

## Mazda 2 10/2007 - 11/2012 Mazda 2 10/2012-

Partnr.: MZ-029-DH

**DE** Einbauanleitung Elektrosatz Anhängervorrichtung mit 13-P Steckdose lt. DIN/ISO Norm 11446

**FR** Instructions de montage du faisceau électrique pour crochet d'attelage conforme à la norme DIN/ISO 11446 prise 13-V.

**NL** Montage-handleiding elektrokabelset voor trekhaak met 13-P contactdoos vlg. DIN/ISO norm 11446.

**GB** Fitting instructions electric wiring kit tow bar with 13-P socket up to DIN/ISO Norm 11446.

**ES** Instrucciones de montaje de kit eléctrico para enganche de remolque con caja de conexiones 13-P según norma DIN/ISO 11446.

**IT** Istruzioni di montaggio di set di cavi elettrici per gancio da traino con zoccolo a 13-P conforme alla norma DIN/ISO 11446.

**SE** Monteringsanvisningar elkabelsats för dragkrok med 13-P kontaktdosa enligt DIN/ISO norm 11446.

**CZ** Montážní pokyny: souprava pro elektrické propojení tažné tyče s 13-P zásuvkou do normy DIN/ISO 11446.

**DK** Monteringsvejledninger for det elektriske ledningsføringssæt for trækstang med 13-N stikdåse, DIN/ISO, norm 11446.

**FI** Ohjeet vetokoukun sähkökaapelisarjan asentamiseen, jossa on DIN/ISO 11446 mukainen 13-N liitin.

**GR** Οδηγίες συναρμολόγησης ηλεκτρικού σετ καλωδίων μπάρας ρυμούλκησης με υποδοχή 13-P μέχρι DIN/ISO Κανόνας 11446.

**NO** Monteringsanviser elkabelsett for trekrok med 13-P koblingsboks ifølge DIN/ISO norm 11446.

**PL** Instrukcje montażu zestawu okablowania elektrycznego dyszla holowniczego z 13-stykowym gniazdem DIN/ISO 11446.

**DE** - Wir weisen ausdrücklich darauf hin, dass eine unsachgemäße und nicht in einer Fachwerkstatt durchgeführte Montage einen Verzicht auf Entschädigung jeglicher Art insbesondere bezüglich des Produkthaftpflichtrechts zur Folge hat

**FR** - Il est expressément prévu qu' on ne saurait se prévaloir d'un quelconque préjudice contractuel ou réhibitoire si le montage avait été fait en dépit des dites instructions ou dans un garage ne disposant pas des équipements adéquats.

**NL** - Wij wijzen er met nadruk op, dat ondeskundige en niet door een vakkundige werkplaats uitgevoerde montage tot gevolg heeft dat daardoor ieder recht op schadevergoeding, ook op wettelijke aansprakelijkheid inzake producten, vervalt.

**GB** - We would expressly point out that assembly not carried out properly by a competent installer will result in cancellation of any right to damage compensation, in particular those arising by virtue of the product liability act.

**ES** - El montaje inapropiado y efectuado por personal no cualificado originará la pérdida de todo derecho a indemnización o la expiración de toda responsabilidad civil con respecto al producto.

**IT** - Sottolineiamo espressamente che un montaggio inadeguato ed eseguito da un'officina non specializzata ha come conseguenza il decadere di qualsiasi diritto al risarcimento danni, nonché alla responsabilità legale relativa ai prodotti.

**SE** - Vi påpekar med eftertryck att all rätt till skadeersättning och all laglig ansvarighet förfaller om monteringen inte har utförts på rätt sätt och av en professionell verkstad.

**CZ** - Výslovně zdůrazňujeme, že jakákoli montáž, která není provedená ve specializované dílně, má za následek odvolání nároků na kompenzaci jakéhokoli druhu, obzvláště vyplývajících ze zákona o odpovědnosti za způsobené škody.

**DK** - Vi ønsker at gøre udtrykkeligt opmærksom på at forkert samling, der ikke er udført af et specialiseret værksted, resulterer i bortfaldelse af kompenseringskrav af alle slags, i særdeles krav der måtte opstå omkring det lovpligtige ansvar.

**FI** - Korostamme, että kaikki oikeudet vahinkokorvaukseen kuten myös valmistajan laillinen vastuu raukeavatt, mikäli asennusta ei ole toteutettu oikealla tavalla eikä ammattitaitoisen asiantuntijan toimesta.

**GR** - Επισημαίνουμε κατηγορηματικά ότι οποιαδήποτε εσφαλμένη συναρμολόγηση, η οποία δεν έχει πραγματοποιηθεί ειδικό εργαστήριο θα οδηγήσει σε αποποίηση των αξιώσεων επιβολής αποζημιώσεων οποιαδήποτε είδους, ειδικά όσα προκύπτουν από το νόμο ευθύνης προϊόντων.

**NO** - Vi påpeker ettertrykkelig at all rett til skadeerstatning og rettslig ansvar forfaller dersom monteringen ikke er blitt utført på riktig måte og av et profesjonelt verksted.

**PL** - Chcielibyśmy wyraźnie zaznaczyć, iż wszelki nieprawidłowy montaż, który nie jest wykonywany w specjalistycznym warsztacie pociąga za sobą utratę możliwości dochodzenia wszelkiego typu roszczeń, w szczególności tych wynikających z odpowiedzialności producenta za swój produkt.

- Technische Änderungen vorbehalten.  
- Widerstand nur gemäß der Tabelle auf dem Anhänger verwenden.

- Sous réserve de modifications techniques.  
- Ne excédez pas la charge maximale, indiquée dans le tableau.

- Technische wijzigingen voorbehouden.  
- Gebruik alleen belasting volgens aansluittabel op het getrokken voertuig.

- Contents of these kits and their fitting manuals are subject to alteration without notice, please ensure that these instructions are read and fully understood before commencing installation.  
- Do not overload circuits; the maximum loads per connection are detailed in this manual.

- Nos reservamos el derecho a efectuar modificaciones técnicas.  
- Utilice sólo cargas de acuerdo a la tabla de conexión del vehículo remolcado.

- Ci si riserva il diritto di apportare modifiche tecniche.  
- Utilizzare esclusivamente un carico conforme alla tabella degli allacci relativa al veicolo in questione.

- Tekniska ändringar förbehålles.  
- Använd endast belastning enligt anslutningstabellen på det dragna fordonet.

- Změny mohou být provedeny bez oznámení.  
- Používejte pouze při maximálním nabití podle tabulky na tažném vozidle.

- Kan ændres uden varsel.  
- Brug kun den maksimale belastning, i overensstemmelse med forbindelsestabelen for bugserede køretøjer.

- Oikeus teknisiin muutoksiin ilman erillistä huomautusta pidetään.  
- Kuormita työvirtapiiriä ainoastaan hinattavan ajoneuvon kytkentäkaavion mukaisesti.

- Μπορεί να τροποποιηθεί χωρίς προηγούμενη ειδοποίηση.  
- Χρησιμοποιείτε μόνο μέγιστο ηλεκτρικό φορτίο σύμφωνα με τον πίνακα σύνδεσης στο ρυμούλκούμενο όχημα.

- Tekniske endringer forbeholdes. - Overskrid ikke grensene anviset i tilkoblingstabellen på tilhengeren eller det tilkoblede kjøretøyet.

- Podlega zmianom bez powiadomienia.  
- Używać tylko takiego maksymalnego obciążenia które wynika z tabliczki połączeń holowanego pojazdu.

DE

FR

NL

GB

ES

IT

SE

CZ

DK

FI

GR

NO

PL

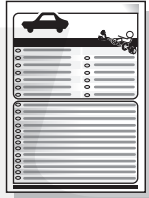
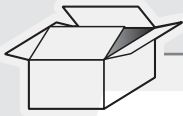

R1



G

OPTION +30/+15

\*

M2

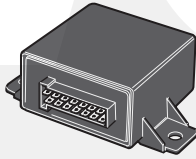

M1

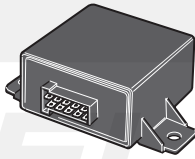

M1



2x

M2

\* OPTION PDC

L2

L1

X

U2

+30



U1

U3



T



15x

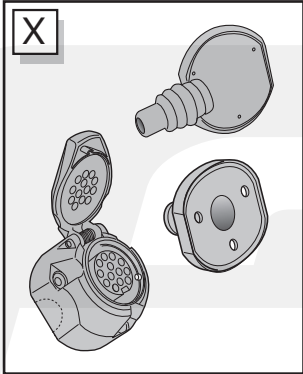

X

\* OPTION +30/+15

vorbereitung für  
préparation pour  
voorbereiding voor  
preparation for  
preparación para  
preparazione per  
förberedelse för  
příprava pro  
forberedelse for  
valmistelu varten  
Προετοιμασία για  
forberedelse på  
przygotowanie do

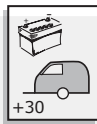

+30

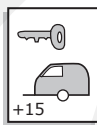

+15

|                   |                     |
|-------------------|---------------------|
| DE Braun/Weiß     | CZ Hnědo/Bílá       |
| FR Marron/Blanc   | DK Brun/Hvid        |
| NL Bruin/Wit      | FI Ruskea/Valkoinen |
| GB Brown/White    | GR Καφέ/Λευκό       |
| ES Marrón/Blanco  | NO Brun/Hvit        |
| IT Marrone/Bianco | PL Brązowy/Biały    |
| SE Brun/Vit       |                     |
| DE Rot            | CZ Červená          |
| FR Rouge          | DK Rød              |
| NL Rood           | FI Punainen         |
| GB Red            | GR Κόκκινο          |
| ES Rojo           | NO Rød              |
| IT Rosso          | PL Czerwony         |
| SE Röd            |                     |

\* OPTION P.D.C.

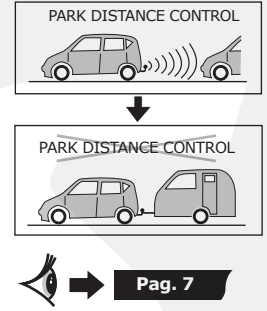

Pag. 7

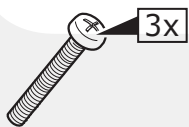

3x

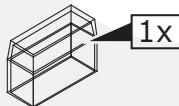

1x

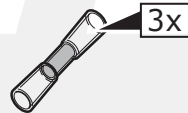

3x



3x

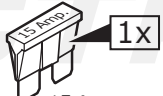

1x

15 Amp.



1x

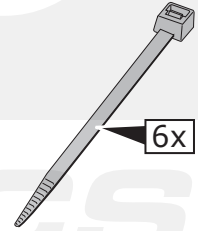

6x

**INFO**

|    | BK      | BN      | BU        | GY     | GN      | WH        | YE        | OG           | PE        | PI              | RD       |
|----|---------|---------|-----------|--------|---------|-----------|-----------|--------------|-----------|-----------------|----------|
| DE | Schwarz | Braun   | Blau      | Grau   | Grün    | Weiß      | Gelb      | Orange       | Violett   | Rosa            | Rot      |
| FR | Noir    | Marron  | Bleu      | Gris   | Vert    | Blanc     | Jaune     | Orange       | Violet    | Rose            | Rouge    |
| NL | Zwart   | Bruin   | Blauw     | Grijs  | Groen   | Wit       | Geel      | Oranje       | Paars     | Roze            | Rood     |
| GB | Black   | Brown   | Blue      | Grey   | Green   | White     | Yellow    | Orange       | Purple    | Pink            | Red      |
| ES | Negro   | Marrón  | Azul      | Gris   | Verde   | Blanco    | Amarillo  | Naranja      | Morado    | Rosa            | Rojo     |
| IT | Nero    | Marrone | Blu       | Grigio | Verde   | Bianco    | Giallo    | Arancione    | Viola     | Rosa            | Rosso    |
| SE | Svart   | Brun    | Blå       | Grå    | Grön    | Vit       | Gul       | Orange       | Lila      | Rosa            | Röd      |
| CZ | Černá   | Hnědá   | Modrá     | Šedá   | Zelená  | Bílá      | Žlutá     | Oranžová     | Fialová   | Růžová          | Červená  |
| DK | Sort    | Brun    | Blå       | Grå    | Grøn    | Hvid      | Gul       | Orange       | Lilla     | Pink            | Rød      |
| FI | Musta   | Ruskea  | Sininen   | Harmaa | Vihreä  | Valkoinen | Keltainen | Oranssi      | Purppura  | Vaaleanpunainen | Punainen |
| GR | Μαύρο   | Καφέ    | Μπλε      | Γκρι   | Πράσινο | Λευκό     | Κίτρινο   | Πορτοκαλί    | Μοβ       | Ροζ             | Κόκκινο  |
| NO | Svart   | Brun    | Blå       | Grå    | Grønn   | Hvit      | Gul       | Oransje      | Lilla     | Rosa            | Rød      |
| PL | Czarny  | Brązowy | Niebieski | Szary  | Zielony | Biały     | Żółty     | Pomarańczowy | Purpurowy | Różowy          | Czerwony |

**ROUTING**

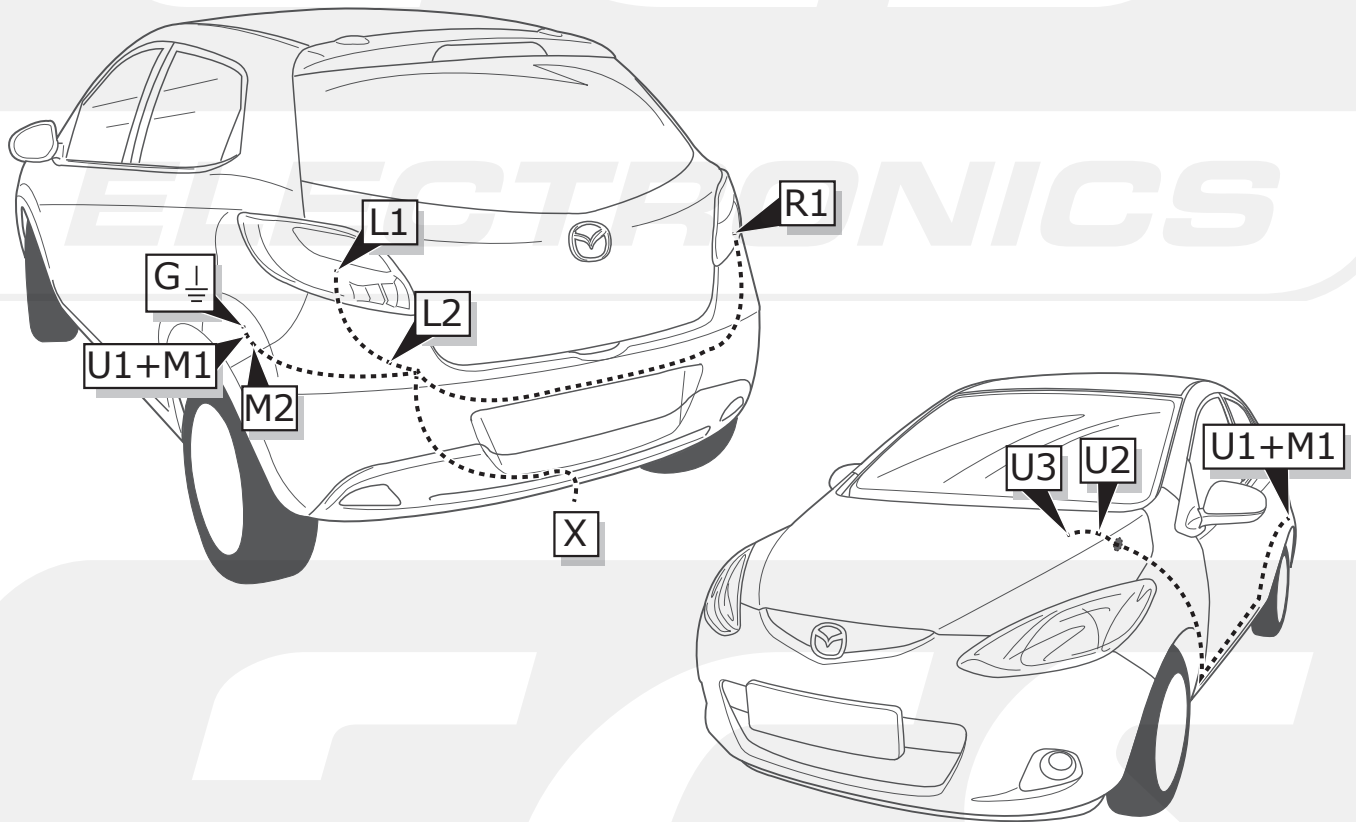

**1**

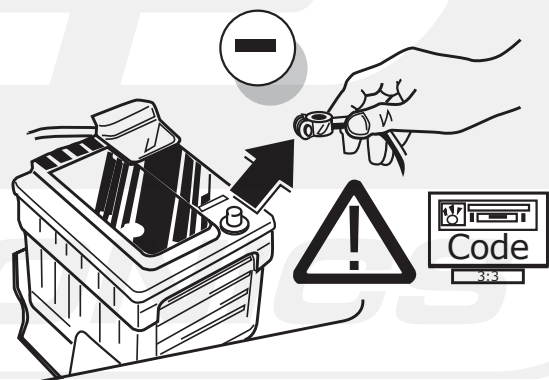
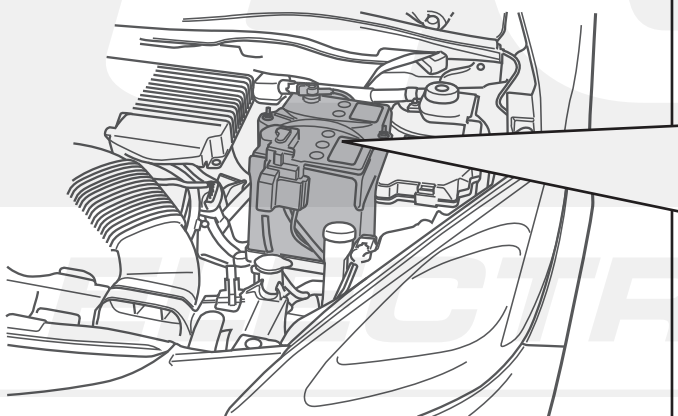

2

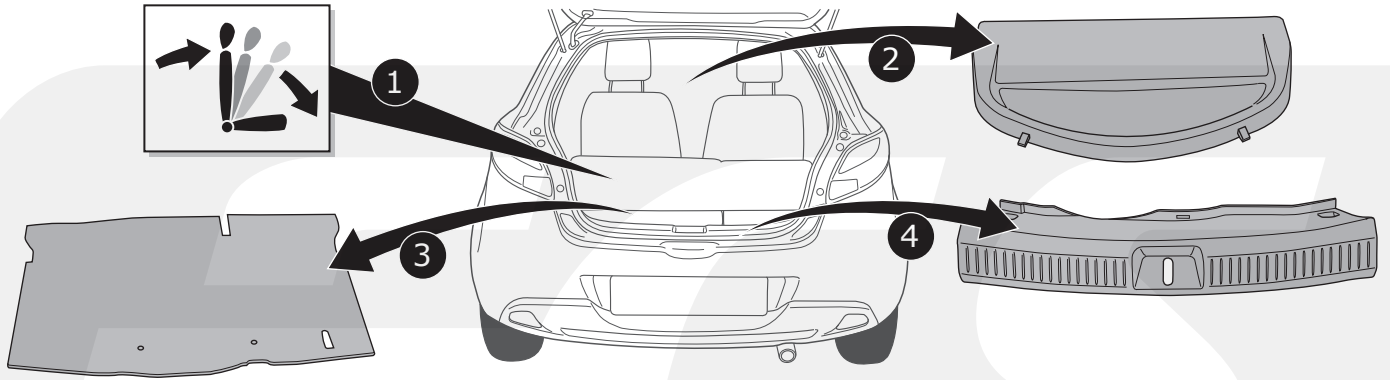

3

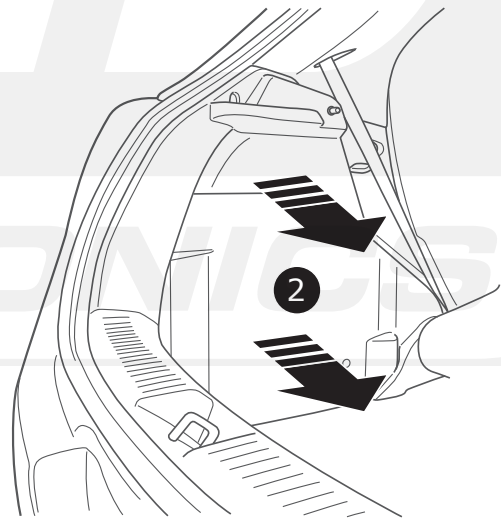
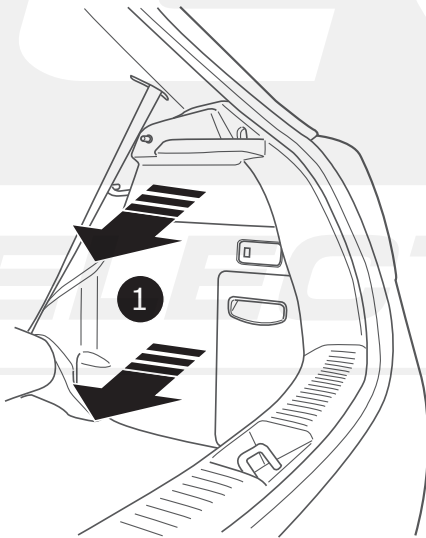

4

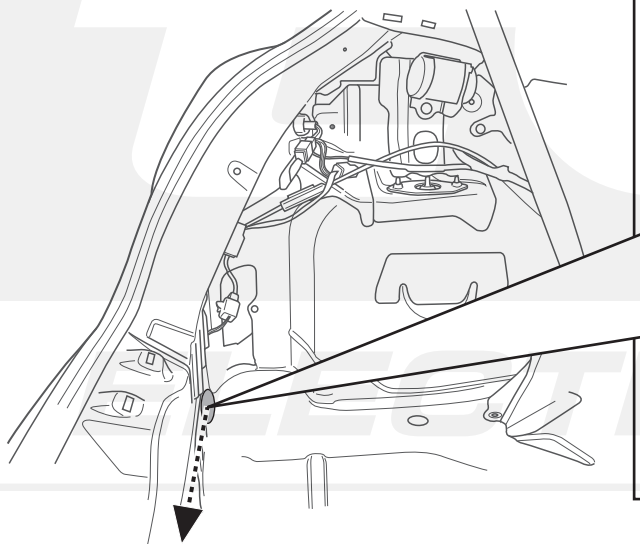
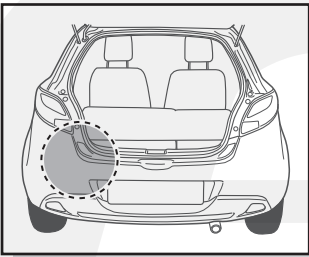

- |                                   |                            |
|-----------------------------------|----------------------------|
| (DE) Klebeband entfernen.         | (CZ) Odstraňte pásku.      |
| (FR) Enlevez Ruban adhésif.       | (DK) Aftag tapen.          |
| (NL) Tape verwijderen.            | (FI) Poista teippi.        |
| (GB) Remove tape.                 | (GR) Αφαιρέστε την ταινία. |
| (ES) Retirar la cinta adhesiva.   | (NO) Fjern limbåndet.      |
| (IT) Rimuovere il nastro adesivo. | (PL) Zdjąć taśmę.          |
| (SE) Avlägsna klisterbandet.      |                            |

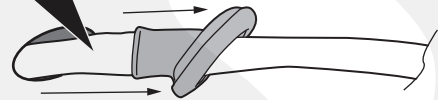

1

X

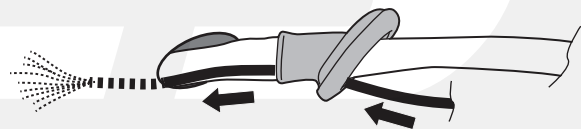

2

X

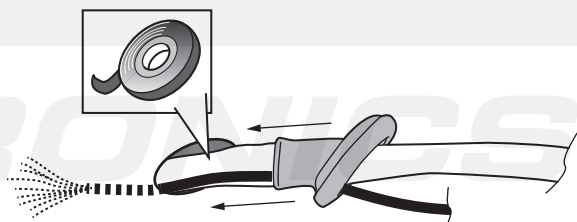

3

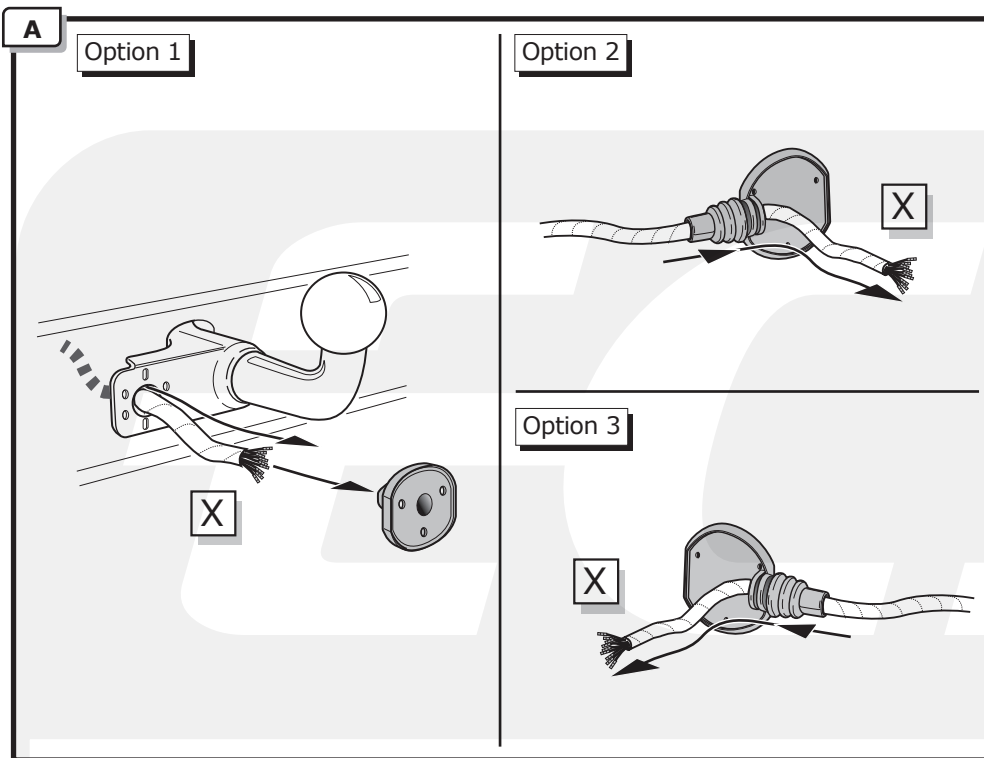

**INFO**

- (DE) Anschluss Steckdose
- (FR) Connection de la prise
- (NL) Contactdoos aansluiting
- (GB) Socket connection
- (ES) Conexión de la caja de enchufe
- (IT) Allaccio zoccolo
- (SE) Anslutning kontaktdosa
- (CZ) Objímkový konektor
- (DK) Stikdåse forbindelse
- (FI) Pistorasia liitäntä
- (GR) Υποδοχή σύνδεσης
- (NO) Tilkobling koblingsboks
- (PL) Połączenie przez gniazdo

**Pag. 11**

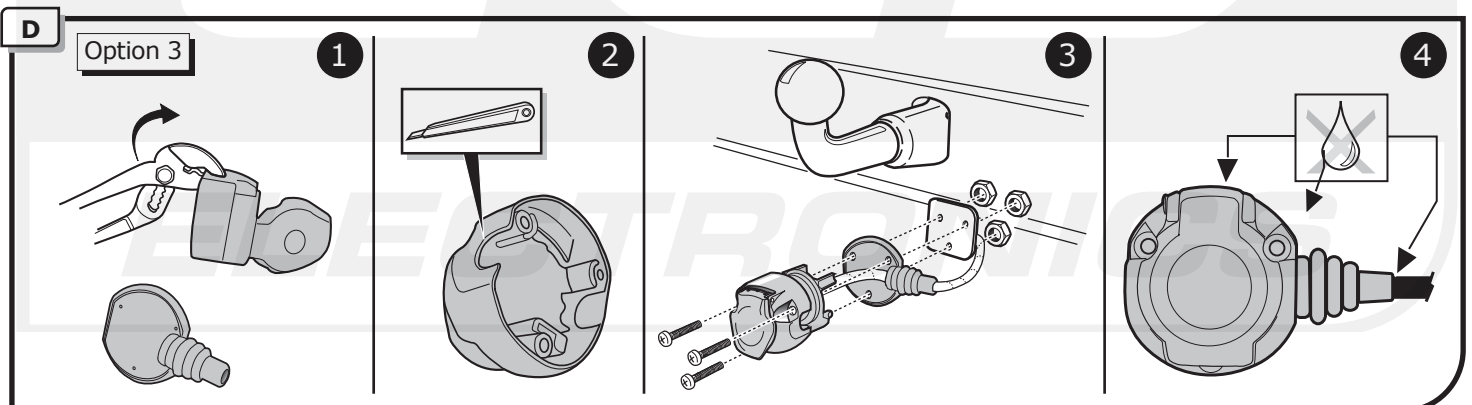
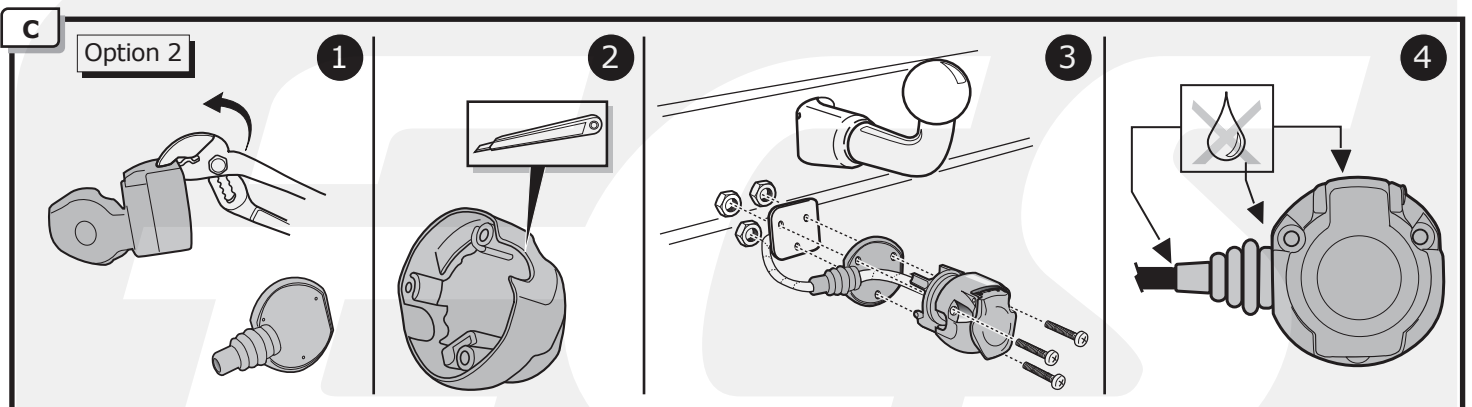
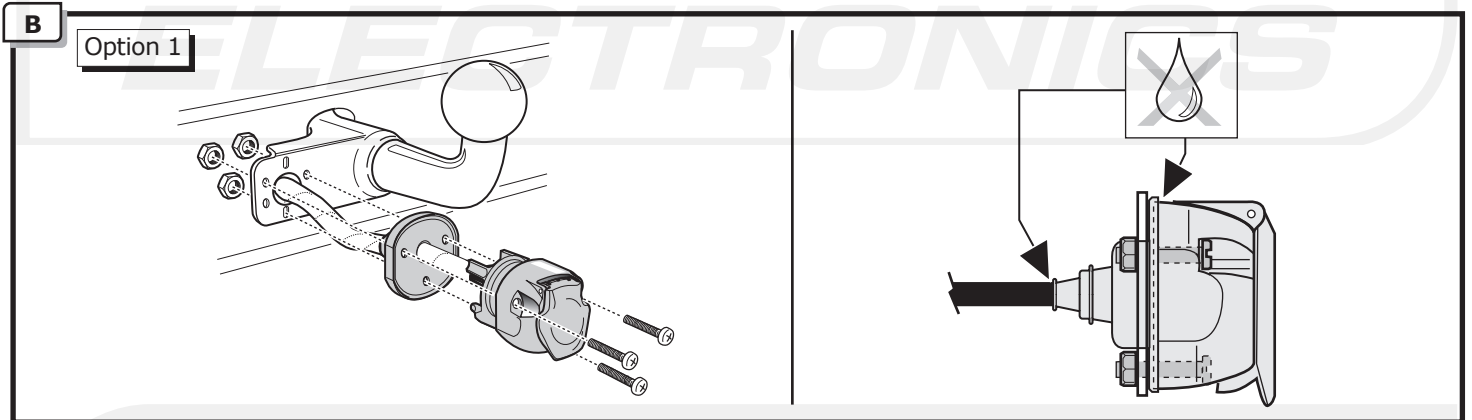



5

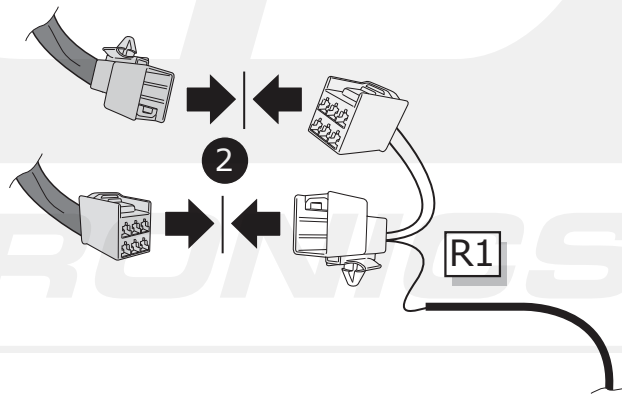
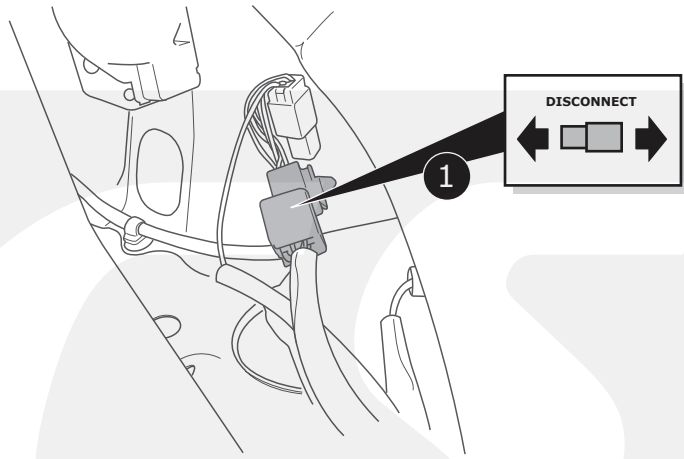
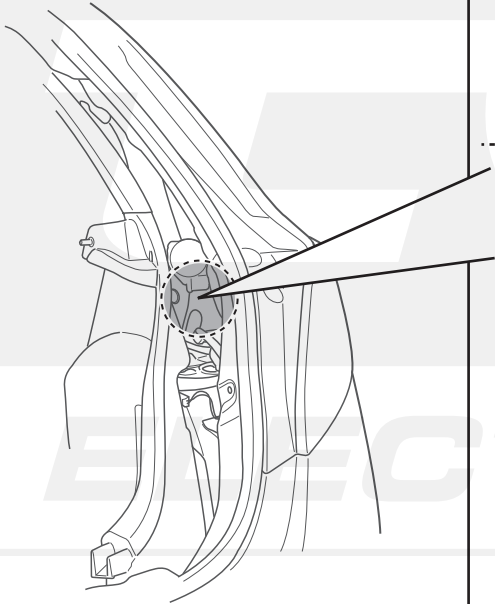
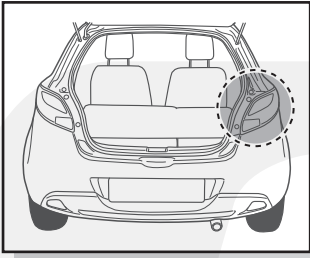

6

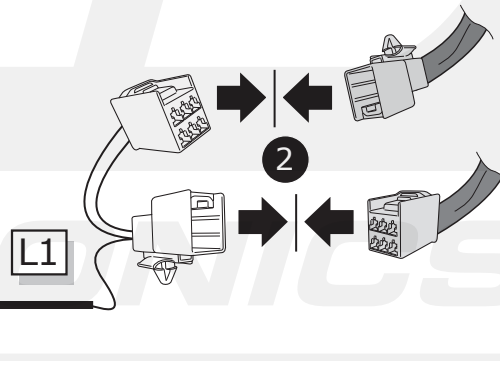
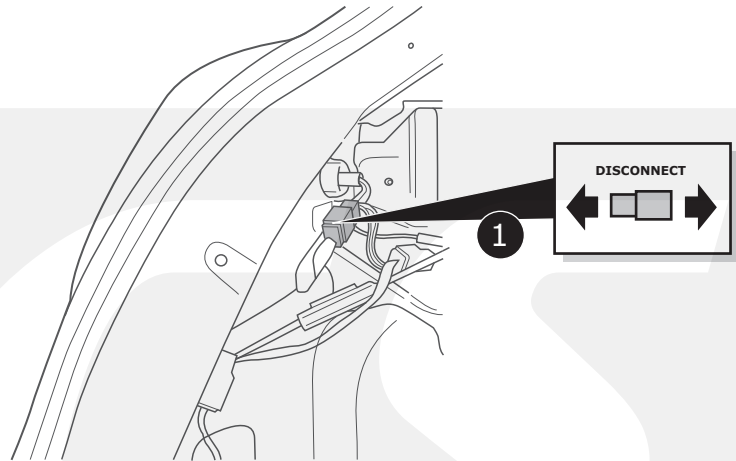
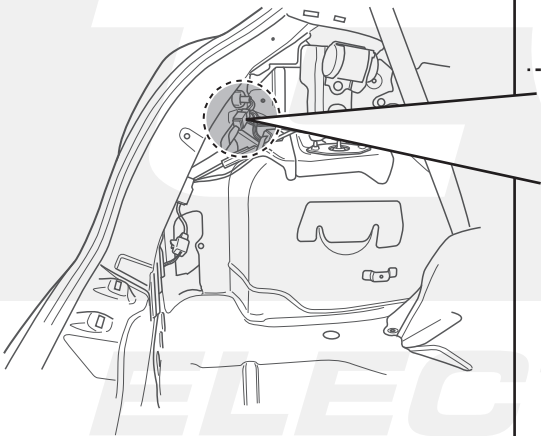
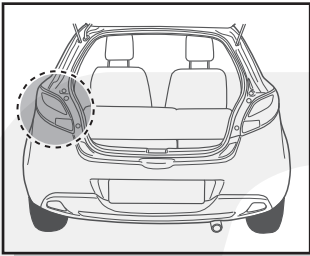

7

**Mazda 2**  
10/2007 - 11/2012

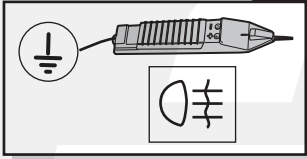

**Mazda 2**  
10/2012-

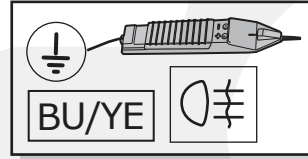
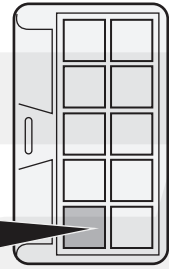

1

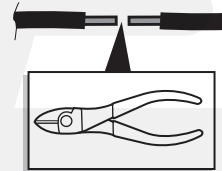
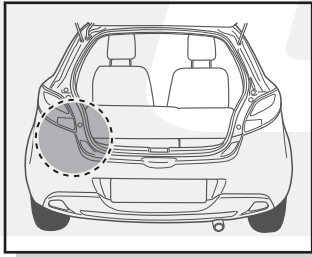

2

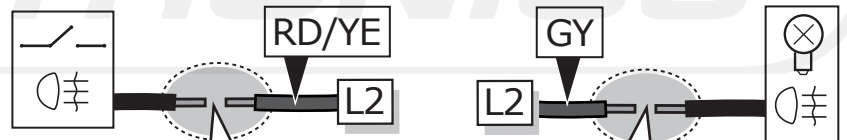
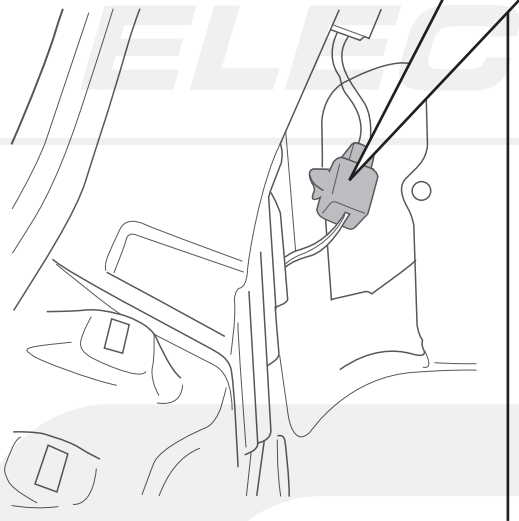

3

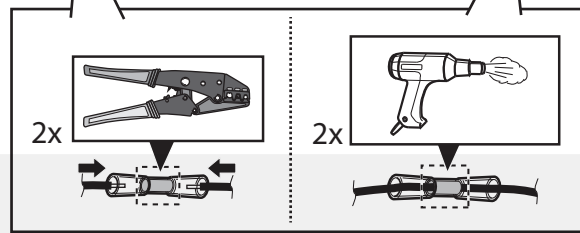

8

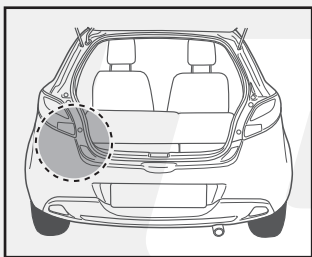

**For OE PDC only**



**Mazda 2**  
10/2012-

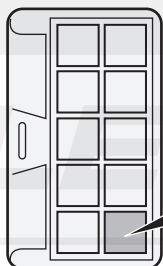

BK/WH

1

PDC

BK/WH

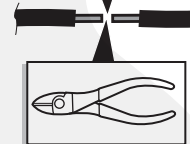

2

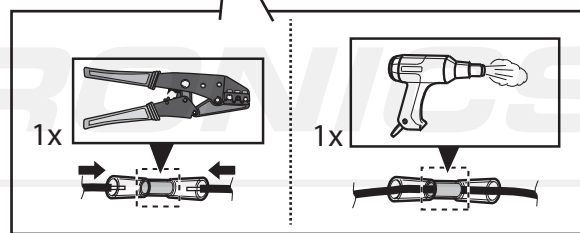

3

9

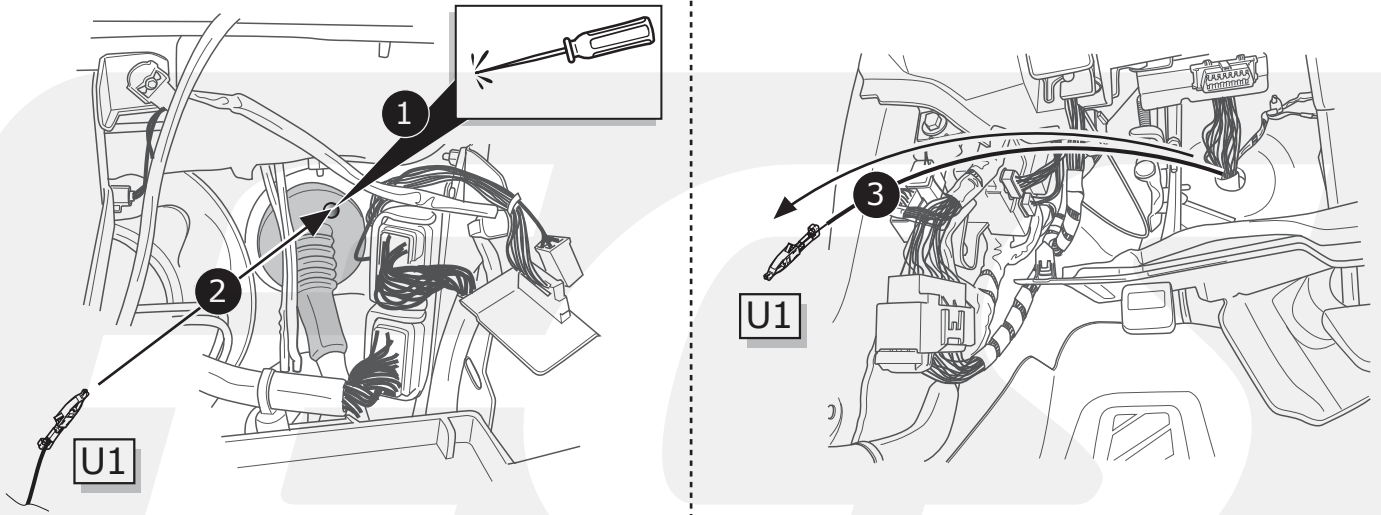

U1

U1

ELECTRONICS

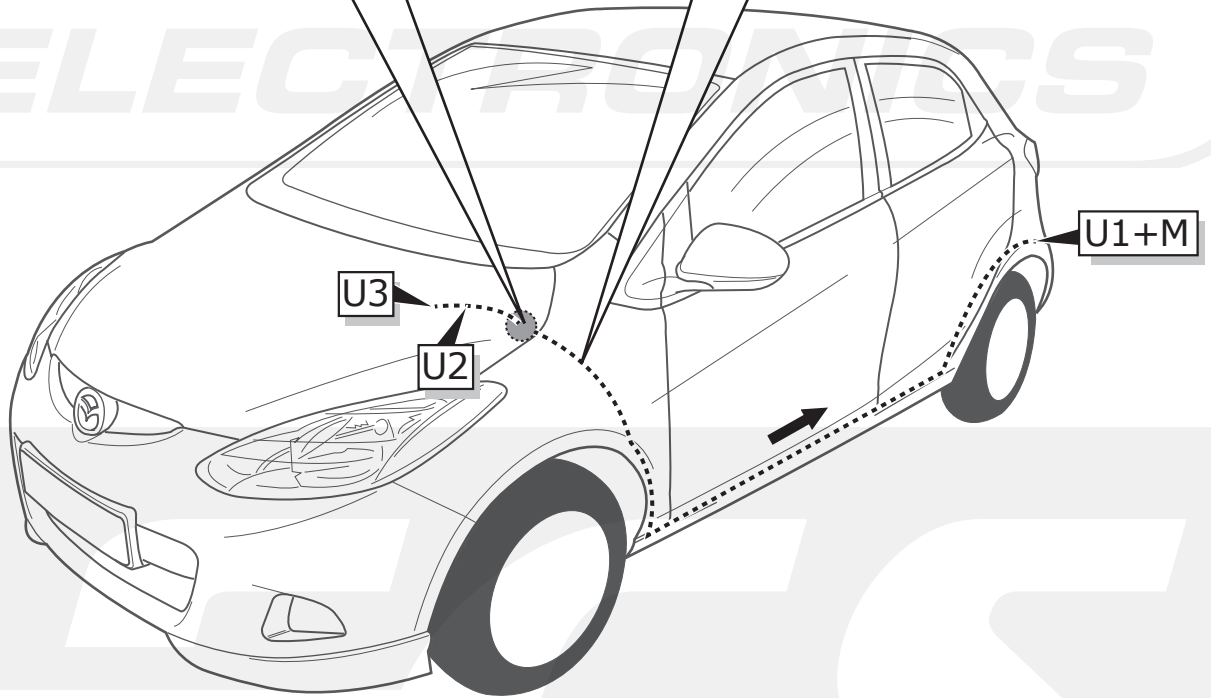

U1+M

U3

U2

10

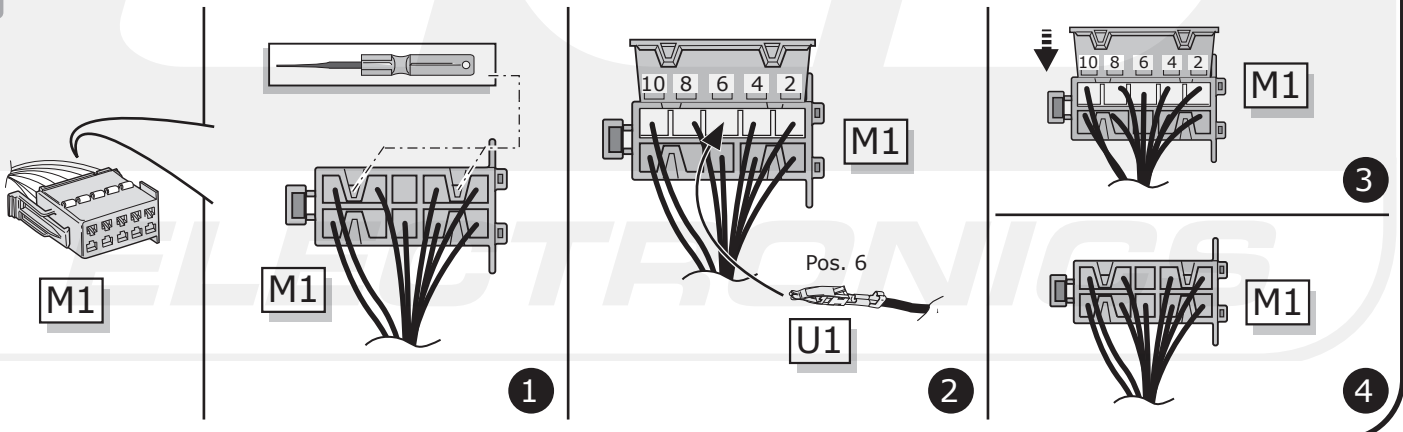

M1

M1

1

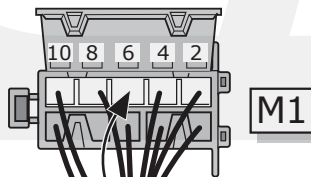

M1

Pos. 6

U1

2

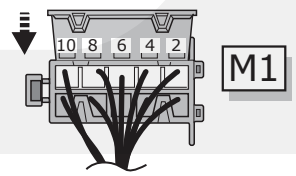

M1

3

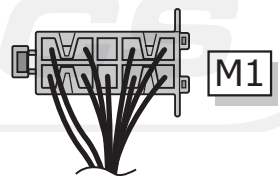

M1

4



11

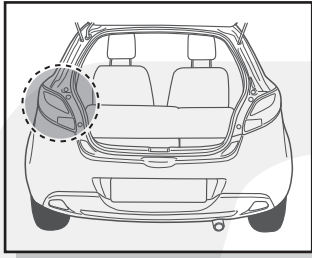

Mazda 2  
10/2012-

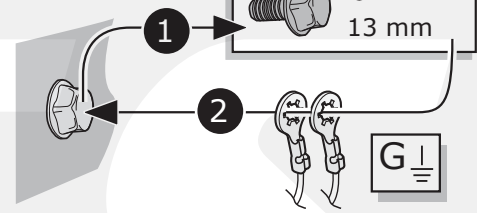

Mazda 2: 10/2007 - 11/2012

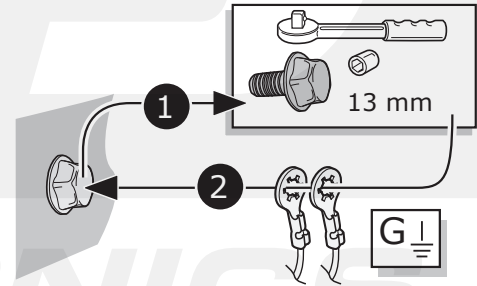

12

**1**

M1

M2

**2**

2x

2x

**3**

M

2x

**4**

M

2x

13

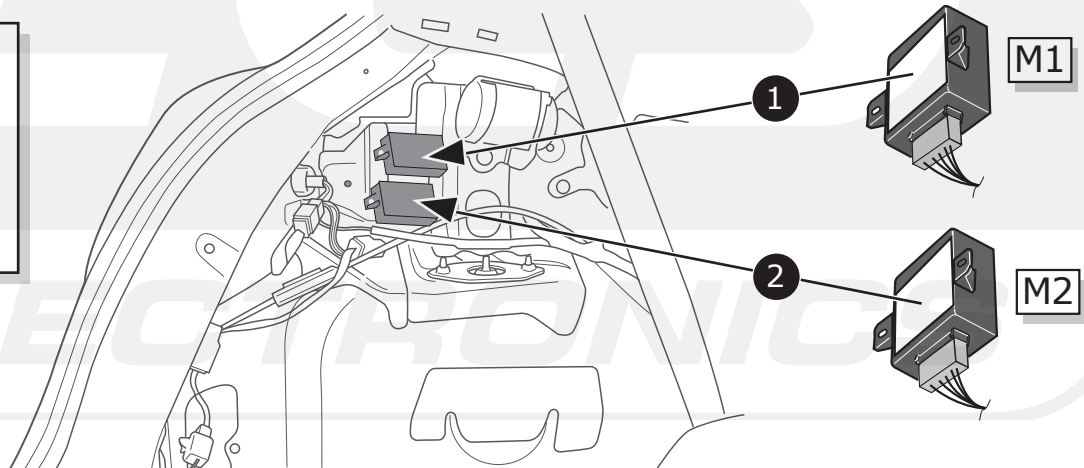
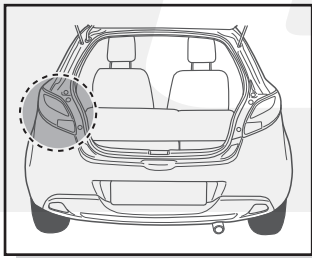

14

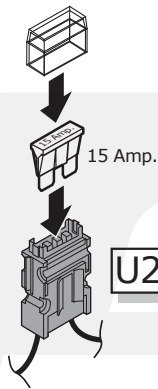

1

U3

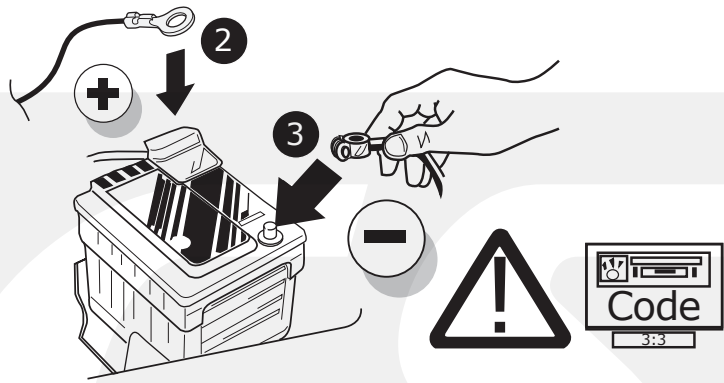

15

DE

FUNKTIONEN KONTROLLIEREN MIT EINEM PRÜFGERÄT MIT WIDERSTAND ODER MIT LEUCHTEN MIT DER GENAUEN WATTZAHL!

FR

CONTRÔLER LES FONCTIONS AVEC UNE BOÎTE DE TEST AVEC DE LA CHARGE OU DES LAMPES AVEC LA QUANTITÉ CORRECTE DE WATT!

NL

CONTROLEER FUNCTIES MET EEN TESTER MET BELASTING OF LAMPEN MET DE JUISTE WATTAGE!

GB

TEST ALL CIRCUIT FUNCTIONS WITH A TESTBOX WITH THE CORRECT POWER LOAD FOR EACH UNIT. A TESTBOX ON WHICH ONLY LEDs ARE USED CAN NOT BE USED IN THIS CASE

ES

¡CONTROLAR FUNCIONES CON UN TESTER CON CARGA O LUCES CON EL CORRECTO WATTAJE!

IT

CONTROLLA FUNZIONI CON UN TESTER CON CARICO O LAMPADIE DEL GIUSTO WATT-TAGGIO!

SE

KONTROLLERA FUNKTIONERNA MED EN TESTARE MED BELASTNING ELLER LAMPOR MED RÄTT WATT-VÄRDE!

CZ

OVĚŘTE FUNKCE POMOČÍ TESTOVACÍHO BOXU NEBO SVĚTEL S PŘÍSLUŠNÝM VÝKONEM!

DK

CHECK FUNKTIONERNE MED EN TESTBOKS, MED BELASTNING ELLER MED LYGTTER MED DET KORREKTE ANTAL WATT!

FI

TARKISTA TOIMINNOT KÄYTTÄMÄLLÄ TESTILAITE, JOSSA ON OIKEATEHOINEN KUORMITUS TAI OIKEATEHOISET LAMPUT!

GR

ΕΛΕΓΞΤΕ ΤΙΣ ΛΕΙΤΟΥΡΓΙΕΣ ΜΕ ΈΝΑ ΚΙΒΩΤΙΟ ΔΟΚΙΜΗΣ ΜΕ ΦΟΡΤΙΟ Ή ΛΑΜΠΗΡΕΣ ΣΩΣΤΗΣ ΠΟΣΟΤΗΤΑΣ ΒΑΤ!

NO

KONTROLER FUNKSJONENE MED EN TESTER MED BELASTNING ELLER LYSFÆRER MED RIKTIG WATTVERDI!

PL

SPRAWDŹ FUNKCJE UŻYWAJĄC SKRZYŃKI TESTOWEJ Z OBCIĄŻENIEM LUB PODŁĄCZONYMI ŻARÓWKAMI O ODPOWIEDNIEJ MOCY!

16

DE

Einzelteile wieder einbauen

FR

Montez les part enlevés

NL

Terug plaatsen onderdelen

GB

Reinstall linings

ES

Reinstalar componentes

IT

Rimetti a posto componenti

SE

Sätt tillbaka delar

CZ

Znovu zasuňte obložení

DK

Påsat beklædningen

FI

Asenna verhoilut takaisin

GR

Τοποθετήστε ξανά τις επενδύσεις

NO

Sett tilbake deler

PL

Założyć wykładzinę

17

DE

Gebrauchsanleitung.

FR

Mode d'emploi.

NL

Gebruikershandleiding.

GB

User guide.

ES

Guía del usuario.

IT

Manuale di istruzioni.

SE

Bruksanvisning.

CZ

Uživatelská příručka.

DK

Brugervejledning.

FI

Käyttöohjeet.

GR

Οδηγός χρήστη.

NO

Brukerveiledning.

PL

Instrukcja obsługi.

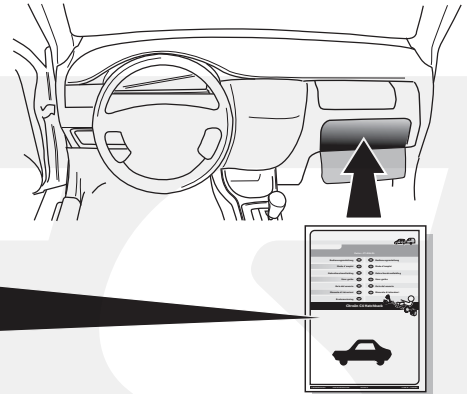

INFO



00800  
CALL2ECS  
22 55 23 27

09.00 - 18.00

Monday - Friday

www.ecs-electronics.nl

## Products & Service

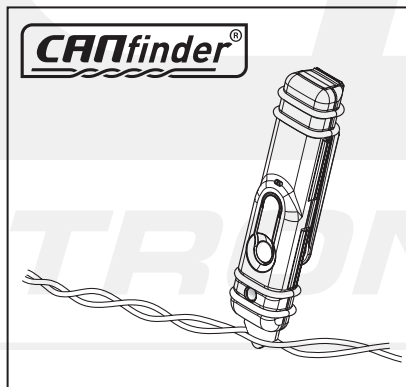

**LIGHT MATE**



[http://www.ecs-electronics.nl/NL/catalogus/test\\_gereedschap](http://www.ecs-electronics.nl/NL/catalogus/test_gereedschap)

(DE) Anschluss Steckdose  
 (FR) Connection de la prise  
 (NL) Contactdoos aansluiting  
 (GB) Socket connection

(ES) Conexión de la caja de enchufe  
 (IT) Allaccio zoccolo  
 (SE) Anslutning kontaktdosa

(CZ) Objímkový konektor  
 (DK) Stikdåse forbindelse  
 (FI) Pistorasia liitäntä  
 (GR) Υποδοχή σύνδεσης  
 (NO) Tilkobling koblingsboks  
 (PL) Połączenie przez gniazdo

| DIN/ISO<br>11446 | ↔         |           | ≡ 1-8     | ↕       |         |         | ⊙                                  |         | Reverse             |                      |                                    | ≡ 10        | —                      | ≡ 9       |
|------------------|-----------|-----------|-----------|---------|---------|---------|------------------------------------|---------|---------------------|----------------------|------------------------------------|-------------|------------------------|-----------|
| Pmax             | 1/L       | 2         | 3/31      | 4/R     | 5/58-R  | 52W     | 6/54                               | 7/58-L  | 8                   | 9                    | 10                                 | 11          | 12                     | 13        |
|                  | 21W       | 2x21W     | 21W       | 21W     | 52W     | 52W     | 3x21W                              | 52W     | 2x21W               | 180W/15Amp.          | 180W/15Amp.                        | 180W/15Amp. |                        |           |
| (DE)             | Gelb      | Blau      | Weiß      | Grün    | Braun   | Schwarz | Rot<br>(1,00mm <sup>2</sup> )      | Schwarz | Schwarz/<br>Rot     | Braun/<br>Weiß       | Rot<br>(2,50mm <sup>2</sup> )      | Weiß        | Rot/<br>Blau           | Weiß      |
| (FR)             | Jaune     | Bleu      | Blanc     | Vert    | Marron  | Noir    | Rouge<br>(1,00mm <sup>2</sup> )    | Noir    | Noir/<br>Rouge      | Marron/<br>Blanc     | Rouge<br>(2,50mm <sup>2</sup> )    | Blanc       | Rouge/<br>Bleu         | Blanc     |
| (NL)             | Geel      | Blauw     | Wit       | Groen   | Bruin   | Zwart   | Rood<br>(1,00mm <sup>2</sup> )     | Zwart   | Zwart/<br>Rood      | Bruin/<br>Wit        | Rood<br>(2,50mm <sup>2</sup> )     | Wit         | Rood/<br>Blauw         | Wit       |
| (GB)             | Yellow    | Blue      | White     | Green   | Brown   | Black   | Red<br>(1,00mm <sup>2</sup> )      | Black   | Black/<br>Red       | Brown/<br>White      | Red<br>(2,50mm <sup>2</sup> )      | White       | Red/<br>Blue           | White     |
| (ES)             | Amarillo  | Azul      | Blanco    | Verde   | Marrón  | Negro   | Rojo<br>(1,00mm <sup>2</sup> )     | Negro   | Negro/<br>Rojo      | Marrón/<br>Blanco    | Rojo<br>(2,50mm <sup>2</sup> )     | Blanco      | Rojo/<br>Azul          | Blanco    |
| (IT)             | Giallo    | Blu       | Bianco    | Verde   | Marrone | Nero    | Rosso<br>(1,00mm <sup>2</sup> )    | Nero    | Nero/<br>Rosso      | Marrone/<br>Bianco   | Rosso<br>(2,50mm <sup>2</sup> )    | Bianco      | Rosso/<br>Blu          | Bianco    |
| (SE)             | Gul       | Blå       | Vit       | Grön    | Brun    | Svart   | Röd<br>(1,00mm <sup>2</sup> )      | Svart   | Svart/<br>Röd       | Brun/<br>Vit         | Röd<br>(2,50mm <sup>2</sup> )      | Vit         | Röd/<br>Blå            | Vit       |
| (CZ)             | Žlutá     | Modrá     | Bílá      | Zelená  | Hnědá   | Černá   | Červená<br>(1,00mm <sup>2</sup> )  | Černá   | Černo/<br>Červená   | Hnědo/<br>Bílá       | Červená<br>(2,50mm <sup>2</sup> )  | Bílá        | Červeno/<br>Modrá      | Bílá      |
| (DK)             | Gul       | Blå       | Hvid      | Grøn    | Brun    | Sort    | Rød<br>(1,00mm <sup>2</sup> )      | Sort    | Sort/<br>Rød        | Brun/<br>Hvid        | Rød<br>(2,50mm <sup>2</sup> )      | Hvid        | Rød/<br>Blå            | Hvid      |
| (FI)             | keltainen | Sininen   | Valkoinen | Vihreä  | Ruskea  | Musta   | Punainen<br>(1,00mm <sup>2</sup> ) | Musta   | Musta/<br>Punainen  | Ruskea/<br>Valkoinen | Punainen<br>(2,50mm <sup>2</sup> ) | Valkoinen   | Punainen/<br>Sininen   | Valkoinen |
| (GR)             | Κίτρινο   | Μπλε      | Λευκό     | Πράσινο | Καφέ    | Μαύρο   | Κόκκινο<br>(1,00mm <sup>2</sup> )  | Μαύρο   | Μαύρο/<br>Κόκκινο   | Καφέ/<br>Λευκό       | Κόκκινο<br>(2,50mm <sup>2</sup> )  | Λευκό       | Κόκκινο/<br>Μπλε       | Λευκό     |
| (NO)             | Gul       | Blå       | Hvit      | Grønn   | Brun    | Svart   | Rød<br>(1,00mm <sup>2</sup> )      | Svart   | Svart/<br>Rød       | Brun/<br>Hvit        | Rød<br>(2,50mm <sup>2</sup> )      | Hvit        | Rød/<br>Blå            | Hvit      |
| (PL)             | Żółty     | Niebieski | Biały     | Zielony | Brazowy | Czarny  | Czerwony<br>(1,00mm <sup>2</sup> ) | Czarny  | Czarny/<br>Czerwony | Brazowy/<br>Biały    | Czerwony<br>(2,50mm <sup>2</sup> ) | Biały       | Czerwony/<br>Niebieski | Biały     |