



**Einbauanleitung Elektrosatz
Anhängervorrichtung mit 12-N Steckdose
lt. DIN/ISO Norm 1724**

**Instructions de montage du faisceau
électrique pour crochet d'attelage
conforme à la norme
DIN/ISO 1724 prise 12-N**

**Fitting instructions electric wiringkit
towbar with 12-N socket up to
DIN/ISO norm 1724**

**Montage-handleiding elektrokabelset voor
trekhaak met 12-N contactdoos
vlg. DIN/ISO norm 1724**

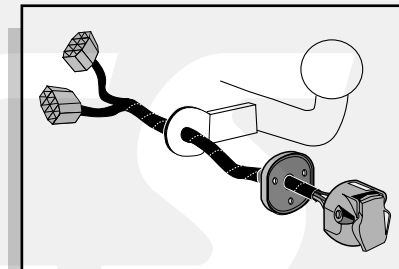

TOYOTA COROLLA SEDAN 2002-

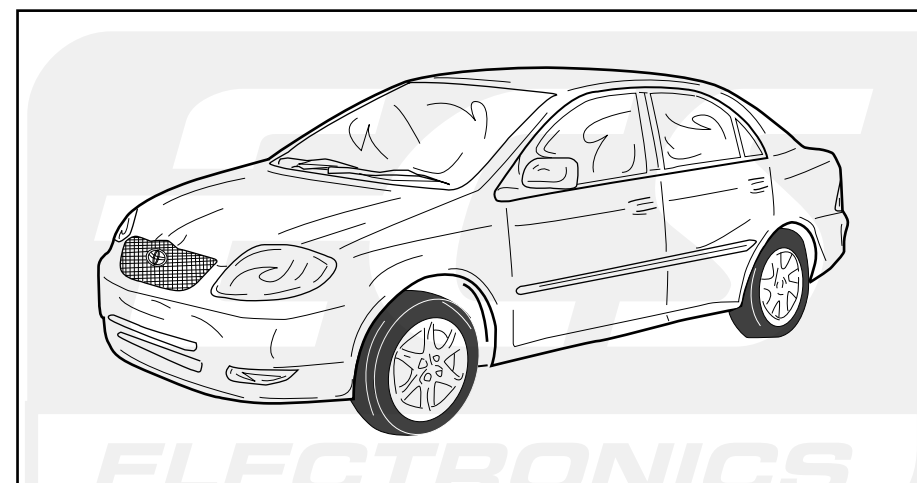

Bestel Nr.: TO-102-BB

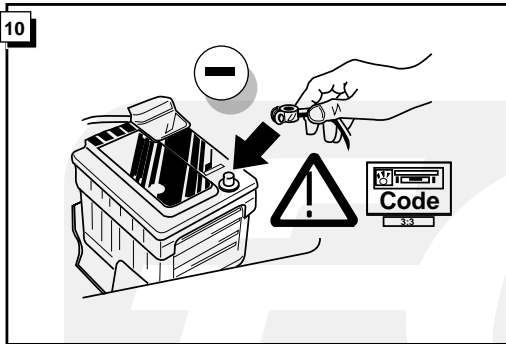

11

FUNKTIONEN KONTROLLIEREN !
CONTRÔLER LES FONCTIONS !
CHECK FUNCTIONS !
CONTROLEER FUNCTIES !

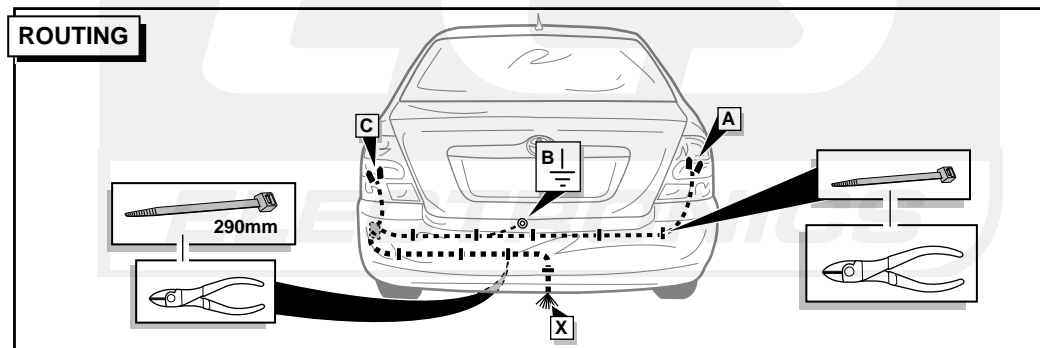
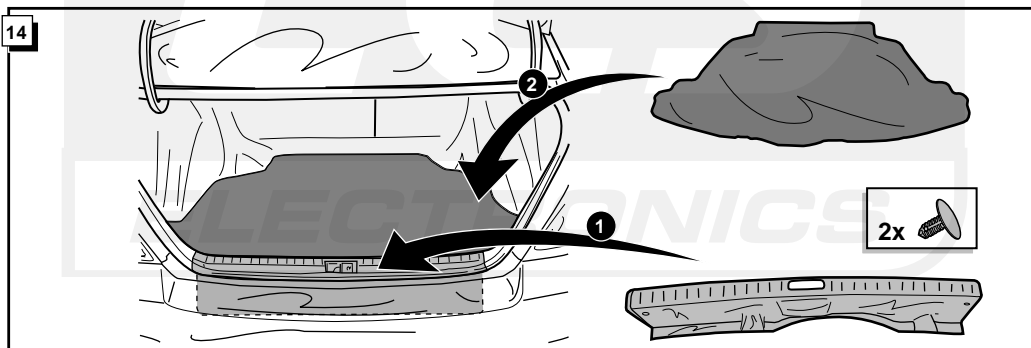
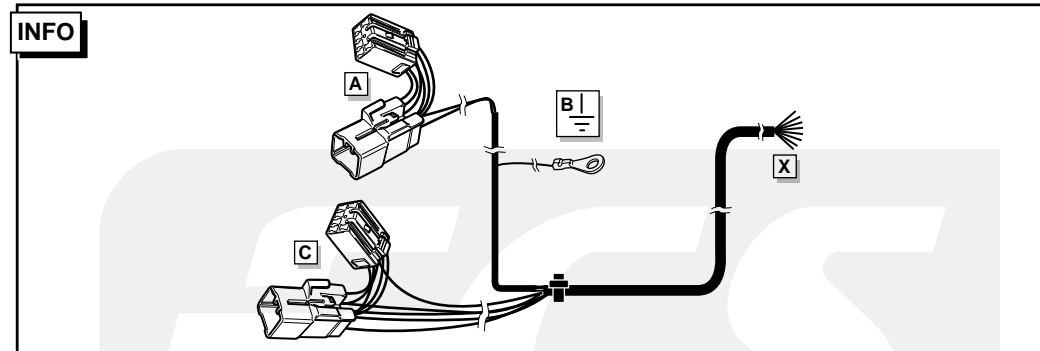
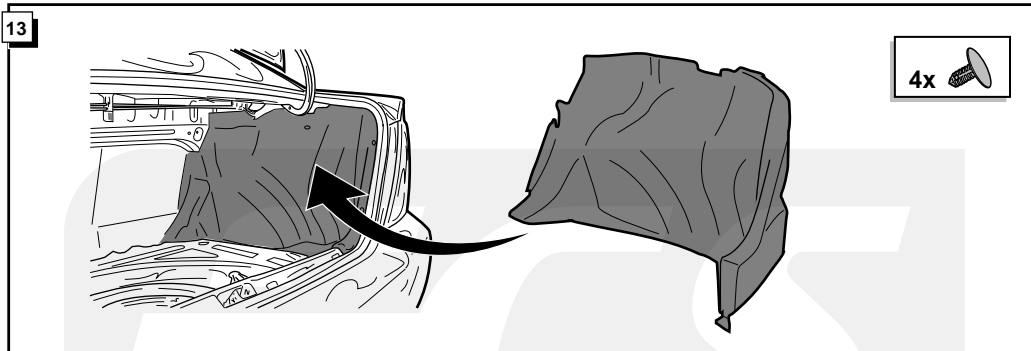
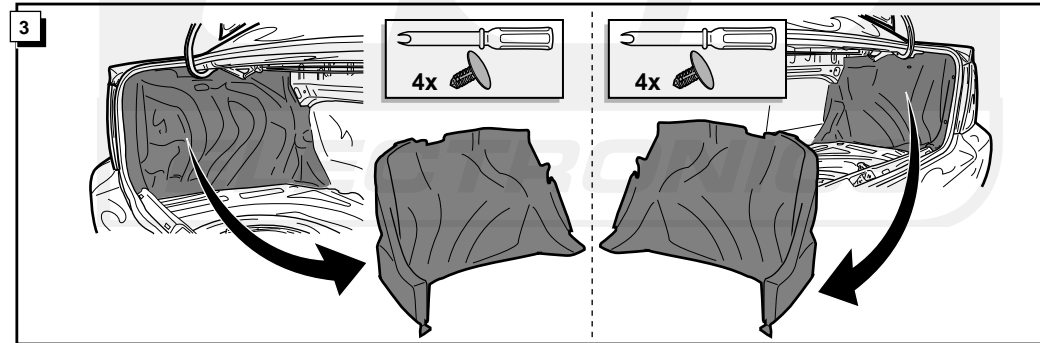
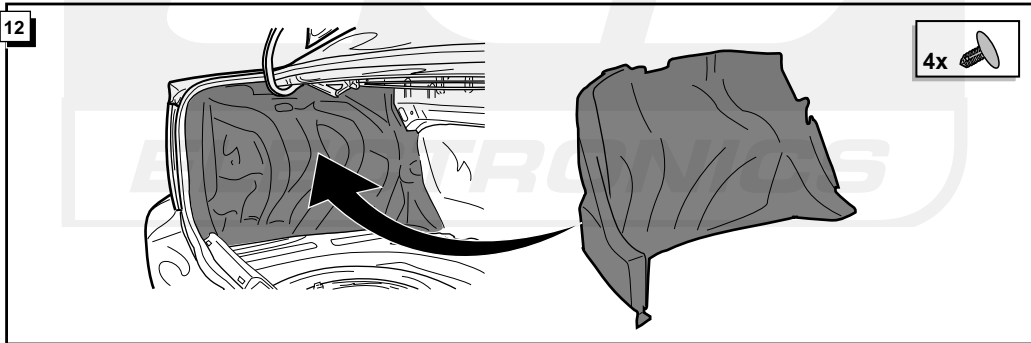
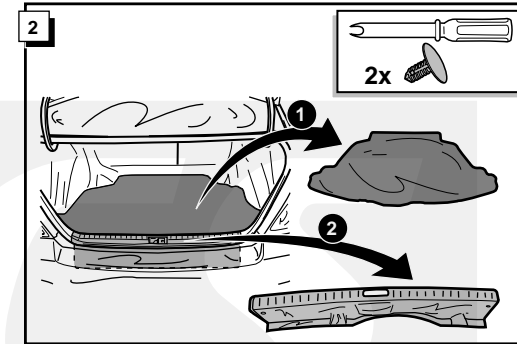
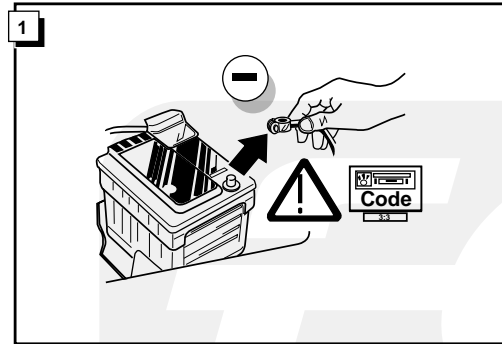

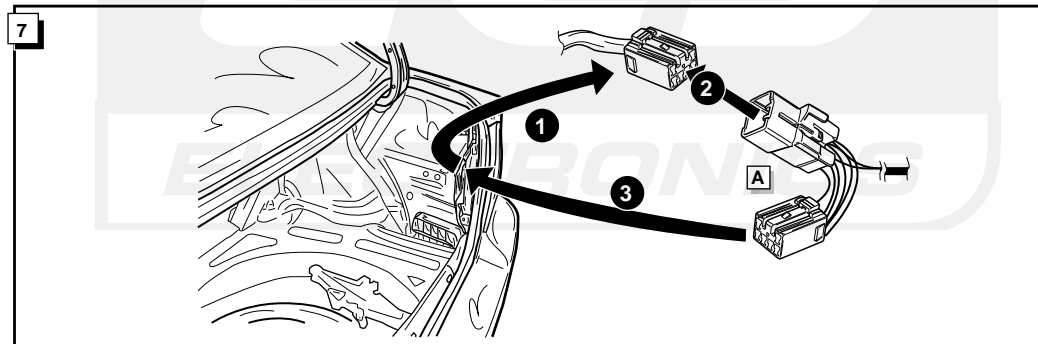
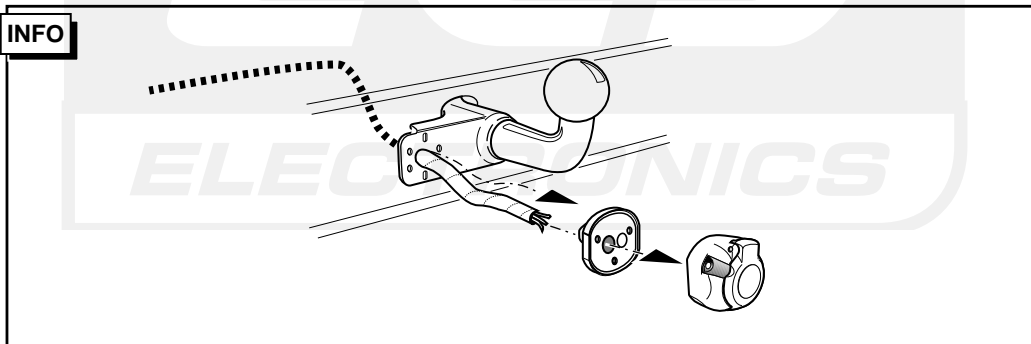
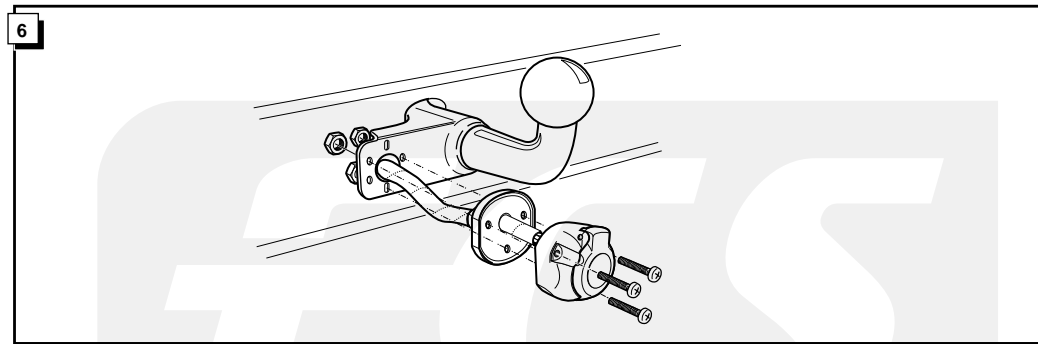
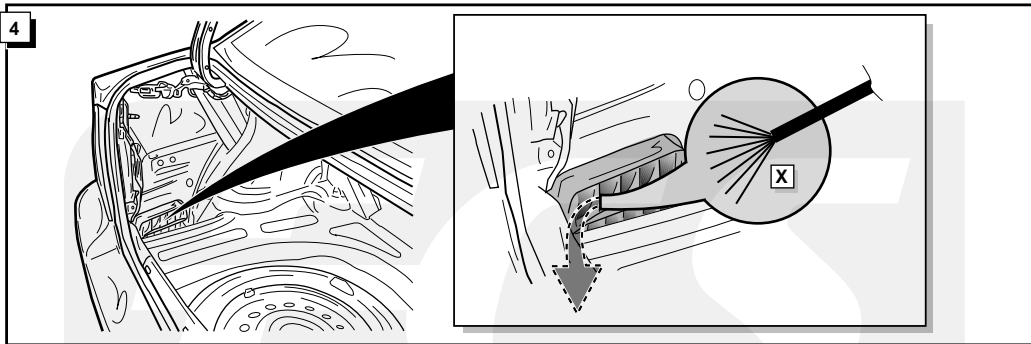

5 **Anschluß Steckdose / Connection de la prise / Socket connection / Contactdoos aansluiting**

DIN/ISO 1724		D	F	GB	NL
	1/L	gelb	jaune	yellow	geel
	2	blau	bleu	blue	blauw
	3/31	weiß	blanc	white	wit
	4/R	grün	vert	green	groen
	5/58-R	braun	marron	brown	bruin
	6/54	rot	rouge	red	rood
	7/58-L	schwarz	noir	black	zwart
	8/58-b	grau	gris	grey	grijs

