

Alfa Romeo Giulietta

Partnr.: AF-011-DH

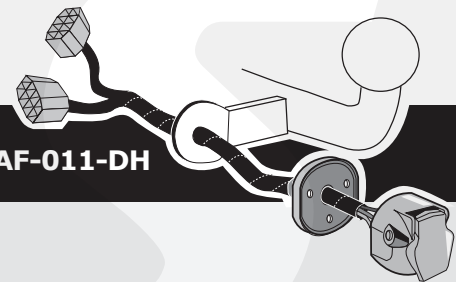

DE Einbauanleitung Elektrosatz Anhängervorrichtung mit 13-P Steckdose lt. DIN/ISO Norm 11446

FR Instructions de montage du faisceau électrique pour crochet d'attelage conforme à la norme DIN/ISO 11446 prise 13-V.

NL Montage-handleiding elektrokabelset voor trekhaak met 13-P contactdoos vlg. DIN/ISO norm 11446.

GB Fitting instructions electric wiring kit tow bar with 13-P socket up to DIN/ISO Norm 11446.

ES Instrucciones de montaje de kit eléctrico para engancho de remolque con caja de conexiones 13-P según norma DIN/ISO 11446.

IT Istruzioni di montaggio di set di cavi elettrici per gancio da traino con connettore a 13-P conforme alla norma DIN/ISO 11446.

SE Monteringsanvisningar elkabelsats för dragkrok med 13-P kontaktdosa enligt DIN/ISO norm 11446.

CZ Montážní pokyny: souprava pro elektrické propojení tažné tyče s 13-P zásuvkou do normy DIN/ISO 11446.

DK Monteringsvejledninger for det elektriske ledningsføringssæt for trækstang med 13-N stikdåse, DIN/ISO, norm 11446.

FI Ohjeet vetokoukun sähkökaapelisarjan asentamiseen, jossa on DIN/ISO 11446 mukainen 13-N liitin.

GR Οδηγίες συναρμολόγησης ηλεκτρικού σετ καλωδίων μπάρας ρυμούλκησης με υποδοχή 13-P μέχρι DIN/ISO Κανόνας 11446.

NO Monteringsanviser elkabelsett for trekrok med 13-P koblingsboks ifølge DIN/ISO norm 11446.

PL Instrukcje montażu zestawu okablowania elektrycznego dyszla holowniczego z 13-stykowym gniazdem DIN/ISO 11446.

DE - Wir weisen ausdrücklich darauf hin, dass eine unsachgemäße und nicht in einer Fachwerkstatt durchgeführte Montage einen Verzicht auf Entschädigung jeglicher Art insbesondere bezüglich des Produkthaftpflichtrechts zur Folge hat

FR - Il est expressément prévu qu' on ne saurait se prévaloir d'un quelconque préjudice contractuel ou rédhitoire si le montage avait été fait en dépit des dites instructions ou dans un garage ne disposant pas des équipements adéquats.

NL - Wij wijzen er met nadruk op, dat ondeskundige en niet door een vakkundige werkplaats uitgevoerde montage tot gevolg heeft dat daardoor ieder recht op schadevergoeding, ook op wettelijke aansprakelijkheid inzake producten, vervalt.

GB - We would expressly point out that assembly not carried out properly by a competent installer will result in cancellation of any right to damage compensation, in particular those arising by virtue of the product liability act.

ES - El montaje inapropiado y efectuado por personal no cualificado originará la pérdida de todo derecho a indemnización o la expiración de toda responsabilidad civil con respecto al producto.

IT - Sottolineiamo espressamente che un montaggio inadeguato ed eseguito da un'officina non specializzata ha come conseguenza il decadere di qualsiasi diritto al risarcimento danni, nonché alla responsabilità legale relativa ai prodotti.

SE - Vi påpekar med eftertryck att all rätt till skadeersättning och all laglig ansvarighet förfaller om monteringen inte har utförts på rätt sätt och av en professionell verkstad.

CZ - Výslovně zdůrazňujeme, že jakákoli montáž, která není provedená ve specializované dílně, má za následek odvolání nároků na kompenzaci jakéhokoli druhu, obzvláště vyplývajících ze zákona o odpovědnosti za způsobené škody.

DK - Vi ønsker at gøre udtrykkeligt opmærksom på at forkert samling, der ikke er udført af et specialiseret værksted, resulterer i bortfaldelse af kompenseringskrav af alle slags, i særdeles krav der måtte opstå omkring det lovpligtige ansvar.

FI - Korostamme, että kaikki oikeudet vahinkokorvaukseen kuten myös valmistajan laillinen vastuu raukeavat, mikäli asennusta ei ole toteutettu oikealla tavalla eikä ammattitaitoisen asiantuntijan toimesta.

GR - Επισημαίνουμε κατηγορηματικά ότι οποιαδήποτε εσφαλμένη συναρμολόγηση, η οποία δεν έχει πραγματοποιηθεί ειδικό εργαστήριο θα οδηγήσει σε απονοίση των αξιώσεων επιβολής αποζημιώσεων οποιαδήποτε είδους, ειδικά όσα προκύπτουν από το νόμο ευθύνης προϊόντων.

NO - Vi påpeker ettertrykkelig at all rett til skadeerstatning og rettslig ansvar forfaller dersom monteringen ikke er blitt utført på riktig måte og av et profesjonelt verksted.

PL - Chcielibyśmy wyraźnie zaznaczyć, iż wszelki nieprawidłowy montaż, który nie jest wykonywany w specjalistycznym warsztacie pociąga za sobą utratę możliwości dochodzenia wszelkiego typu roszczeń, w szczególności tych wynikających z odpowiedzialności producenta za swój produkt.

- Technische Änderungen vorbehalten.
- Widerstand nur gemäß der Tabelle auf dem Anhänger verwenden.

- Sous réserve de modifications techniques.
- Ne excédez pas la charge maximale, indiquée dans le tableau.

- Technische wijzigingen voorbehouden.
- Gebruik alleen belasting volgens aansluittabel op het getrokken voertuig.

- Contents of these kits and their fitting manuals are subject to alteration without notice, please ensure that these instructions are read and fully understood before commencing installation.

- Do not overload circuits; the maximum loads per connection are detailed in this manual.

- Nos reservamos el derecho a efectuar modificaciones técnicas.

- Utilice sólo cargas de acuerdo a la tabla de conexión del vehículo remolcado.

- Ci si riserva il diritto di apportare modifiche tecniche.

- Utilizzare esclusivamente un carico conforme alla tabella degli allacci relativa al veicolo in questione.

- Tekniska ändringar förbehålles.

- Använd endast belastning enligt anslutningstabellen på det dragna fordonet.

- Změny mohou být provedeny bez oznámení.

- Používejte pouze při maximálním nabití podle tabulky na tažném vozidle.

- Kan ændres uden varsel.

- Brug kun den maksimale belastning, i overensstemmelse med forbindelsestabelen for bugserede køretøjer.

- Oikeus teknisiin muutoksiin ilman erillistä huomautusta pidätetään.

- Kuormita työvirtapiiriä ainoastaan hinattavan ajoneuvon kytkentäkaavion mukaisesti.

- Μπορεί να τροποποιηθεί χωρίς προηγούμενη ειδοποίηση.

- Χρησιμοποιείτε μόνο μέγιστο ηλεκτρικό φορτίο σύμφωνα με τον πίνακα σύνδεσης στο ρυμούλκούμενο όχημα.

- Tekniske endringer forbeholdes. - Overskrid ikke grensene anvist i tilkoblingstabellen på tilhengeren eller det tilkoblede kjøretøyet.

- Podlega zmianom bez powiadomienia.

- Używać tylko takiego maksymalnego obciążenia które wynika z tabliczki połączeń holowanego pojazdu.

Einzelteilliste

Liste de pièces

Onderdelenlijst

Part list

Lista de componentes

Elenco componenti

Dellista

Seznam dílů

Del-liste

Osaluettelo

Κατάλογος εξαρτημάτων

Delliste

Lista części

DE

FR

NL

GB

ES

IT

SE

CZ

DK

FI

GR

NO

PL

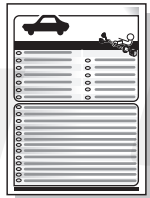
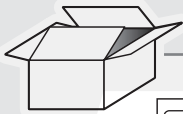

3x

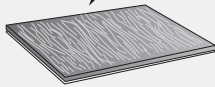

3x



5x

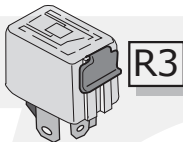
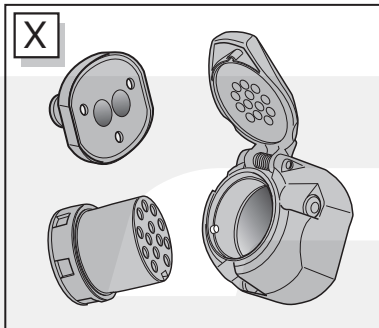
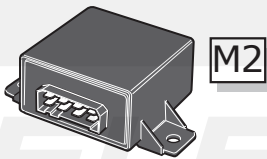
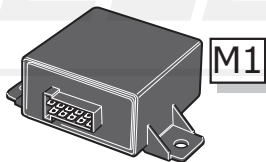

U2

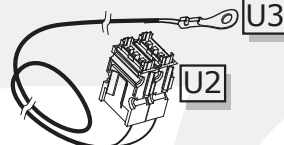

U3

U2

L1

L2

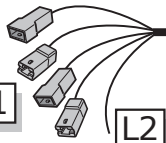

R2

R1

R3

M2

M1



*

*

X

Option! *

PARK DISTANCE CONTROL

PARK DISTANCE CONTROL

Pag. 14

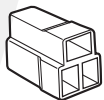

15 Amp.

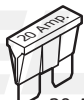

20 Amp.

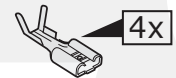

4x

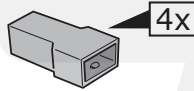

4x



4x

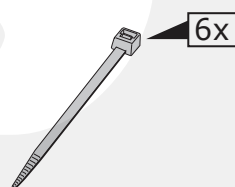

6x

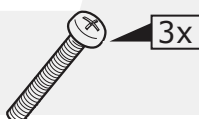

3x



3x



3x

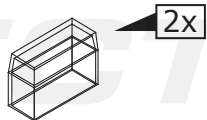

2x

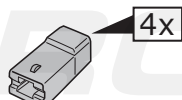

4x

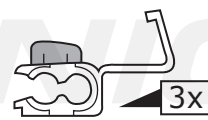

3x

INFO

	BK	BN	BU	GY	GN	WH	YE	OG	PE	PI	RD
DE	Schwarz	Braun	Blau	Grau	Grün	Weiß	Gelb	Orange	Violett	Rosa	Rot
FR	Noir	Marron	Blue	Gris	Vert	Blanc	Jaune	Orange	Violet	Rose	Rouge
NL	Zwart	Bruin	Blauw	Grijs	Groen	Wit	Geel	Oranje	Paars	Roze	Rood
GB	Black	Brown	Blue	Grey	Green	White	Yellow	Orange	Purple	Pink	Red
ES	Negro	Marrón	Azul	Gris	Verde	Blanco	Amarillo	Naranja	Morado	Rosa	Rojo
IT	Nero	Marrone	Blu	Grigio	Verde	Bianco	Giallo	Arancione	Viola	Rosa	Rosso
SE	Svart	Brun	Blå	Grå	Grön	Vit	Gul	Orange	Lila	Rosa	Röd
CZ	Černá	Hnědá	Modrá	Šedá	Zelená	Bílá	Žlutá	Oranžová	Fialová	Růžová	Červená
DK	Sort	Brun	Blå	Grå	Grøn	Hvid	Gul	Orange	Lilla	Pink	Rød
FI	Musta	Ruskea	Sininen	Harmaa	Vihreä	Valkoinen	Keltainen	Oranssi	Purppura	Vaaleanpunainen	Punainen
GR	Μαύρο	Καφέ	Μπλε	Γκρι	Πράσινο	Λευκό	Κίτρινο	Πορτοκαλί	Μοβ	Ροζ	Κόκκινο
NO	Svart	Brun	Blå	Grå	Grønn	Hvit	Gul	Oransje	Lilla	Rosa	Rød
PL	Czarny	Brązowy	Niebieski	Szary	Zielony	Biały	Żółty	Pomarańczowy	Purpurowy	Różowy	Czerwony

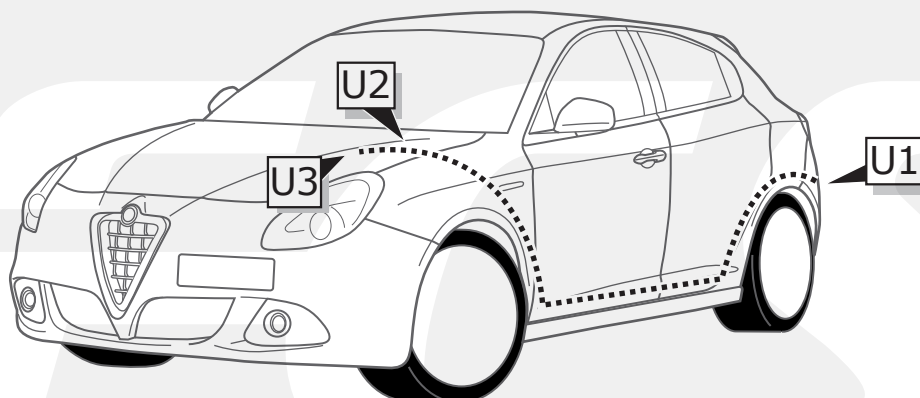
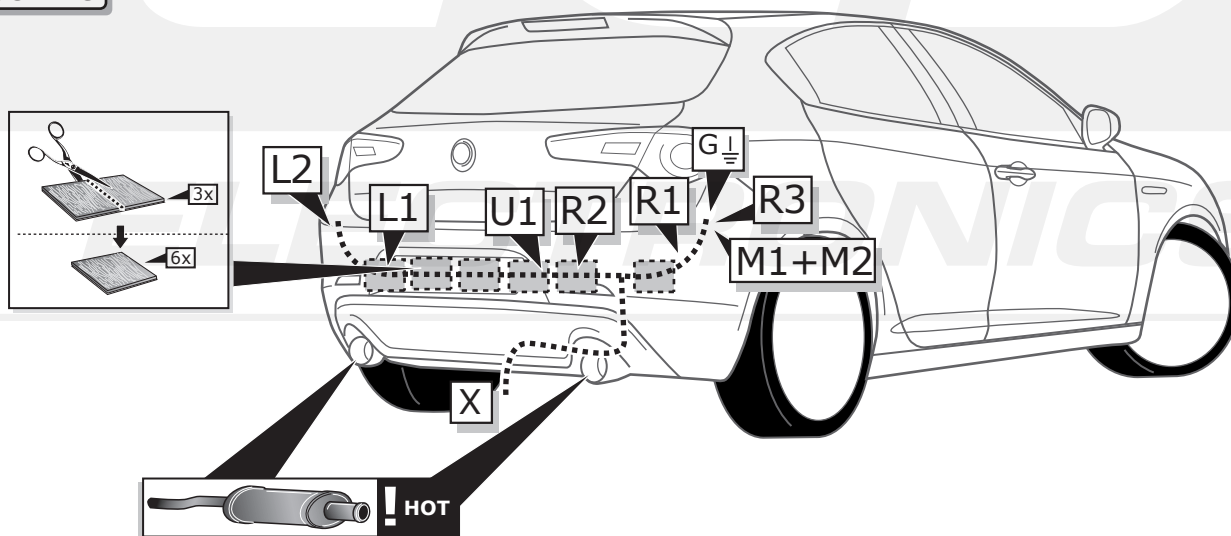
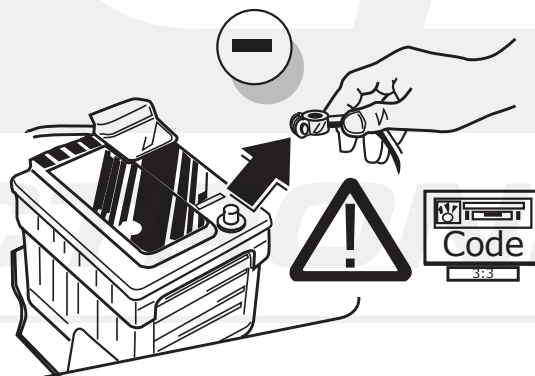
ROUTING

1

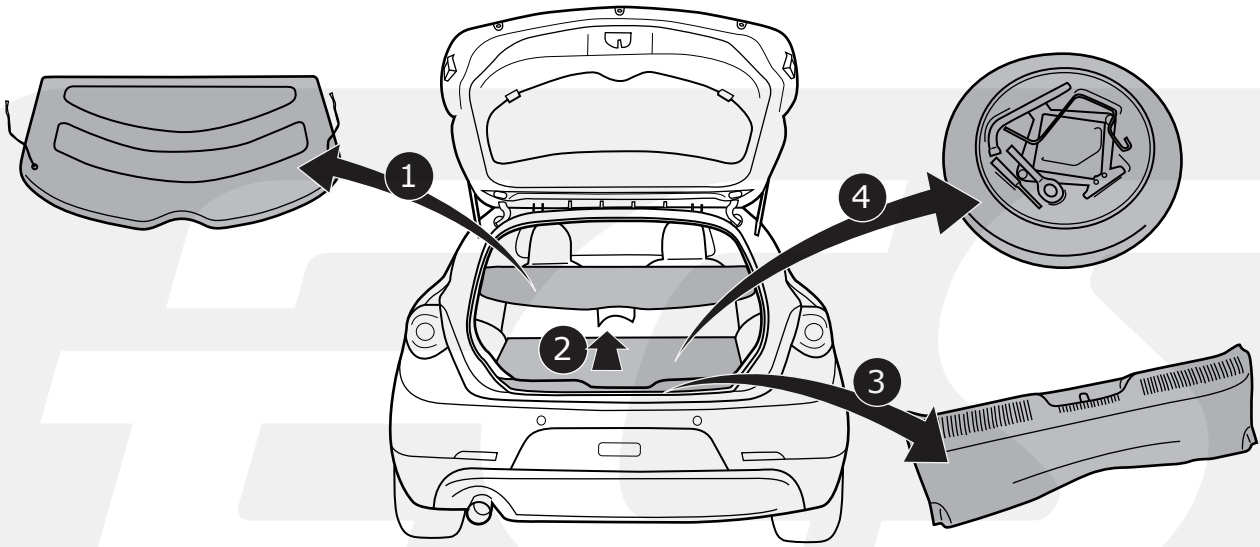
2

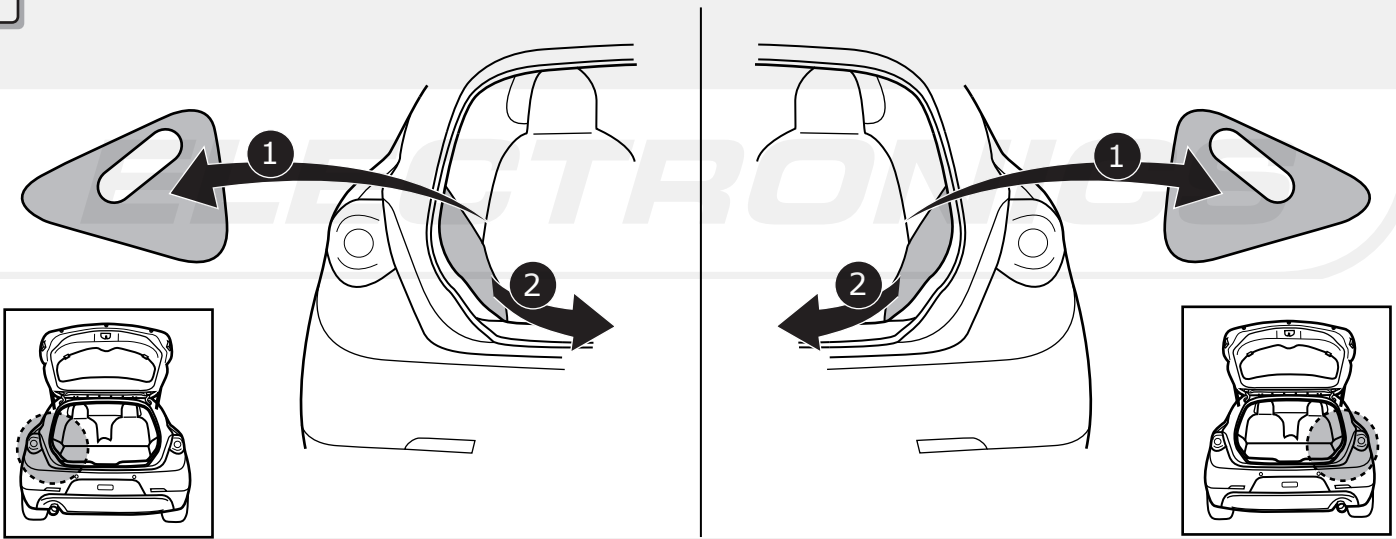

3



4

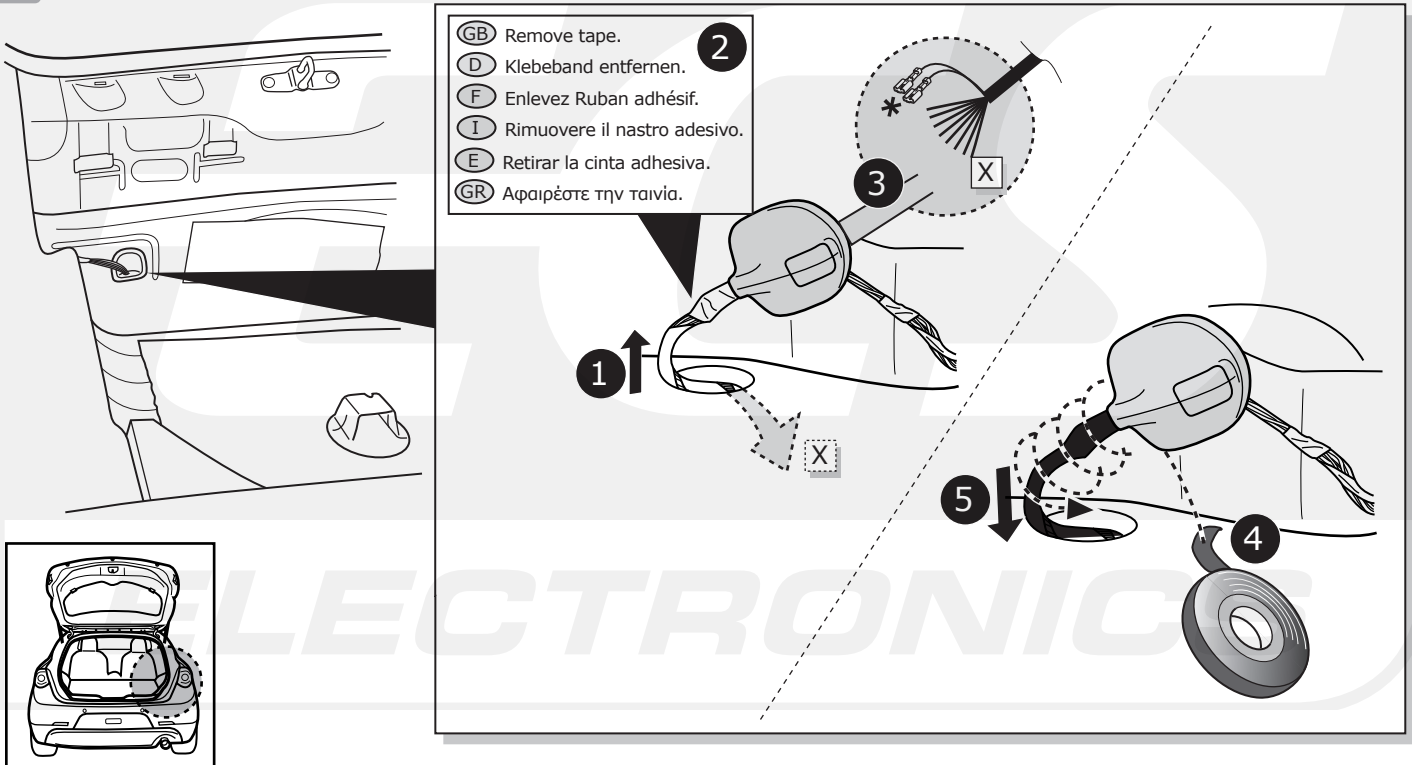

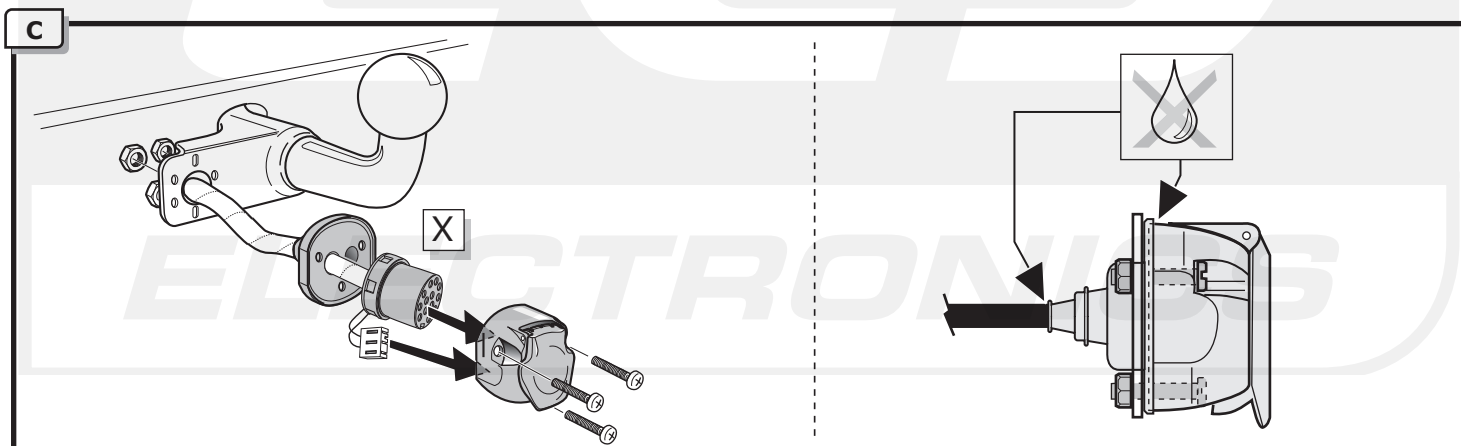
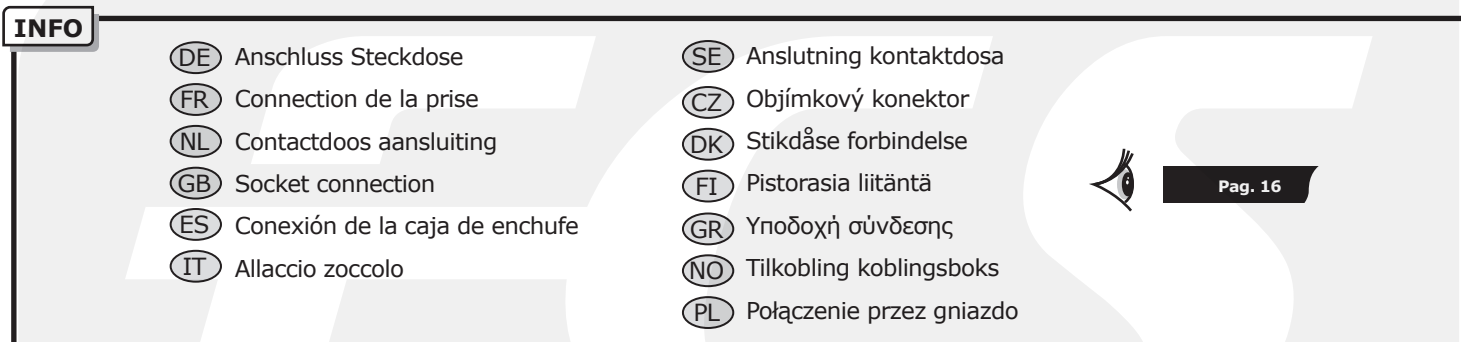
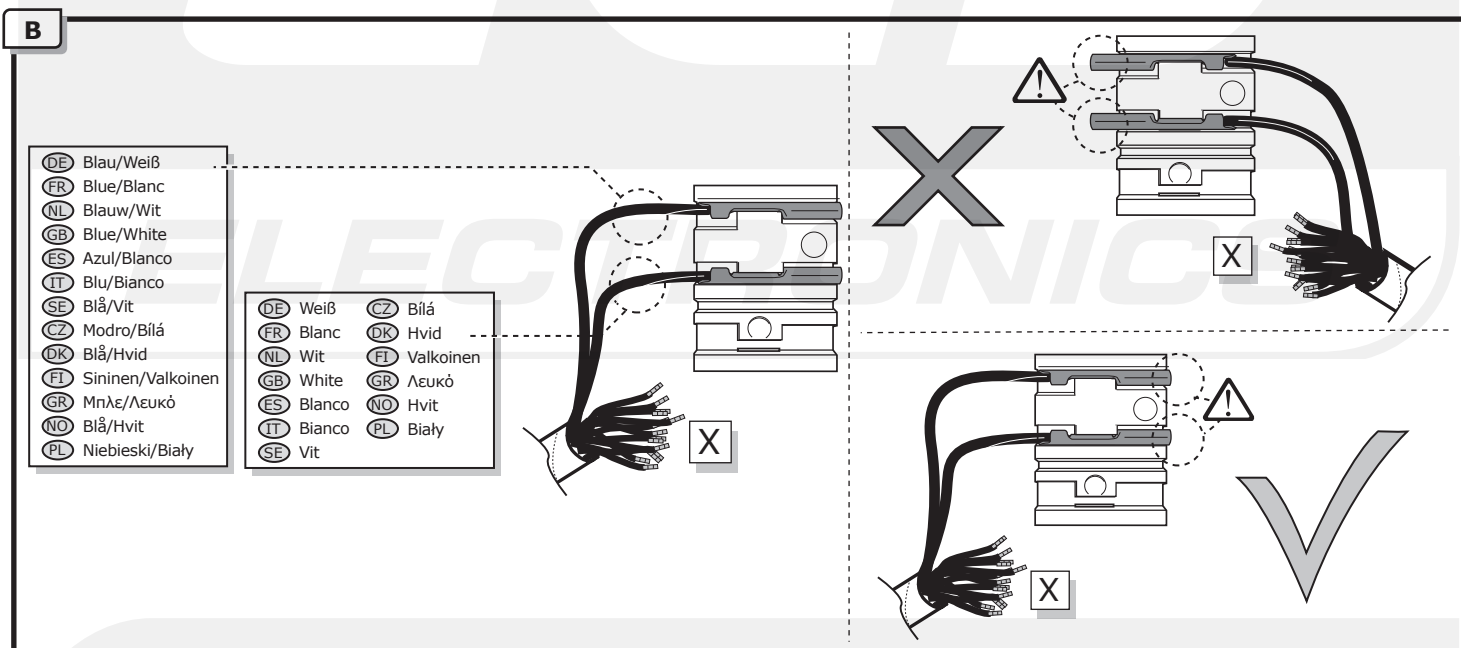
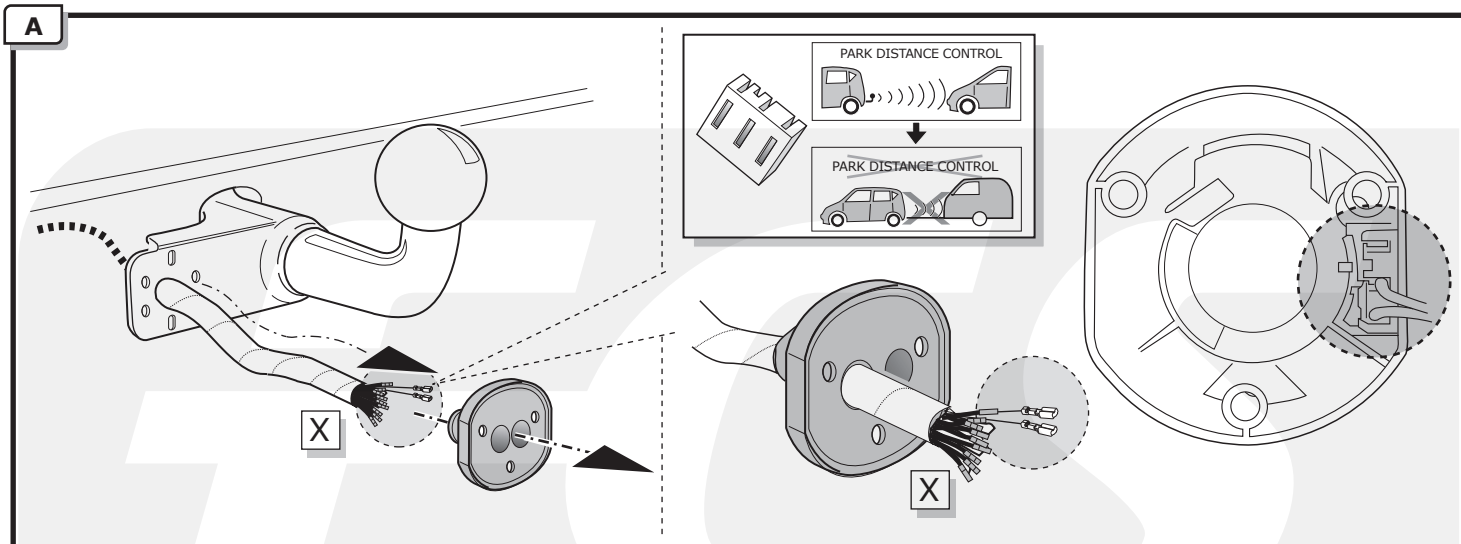

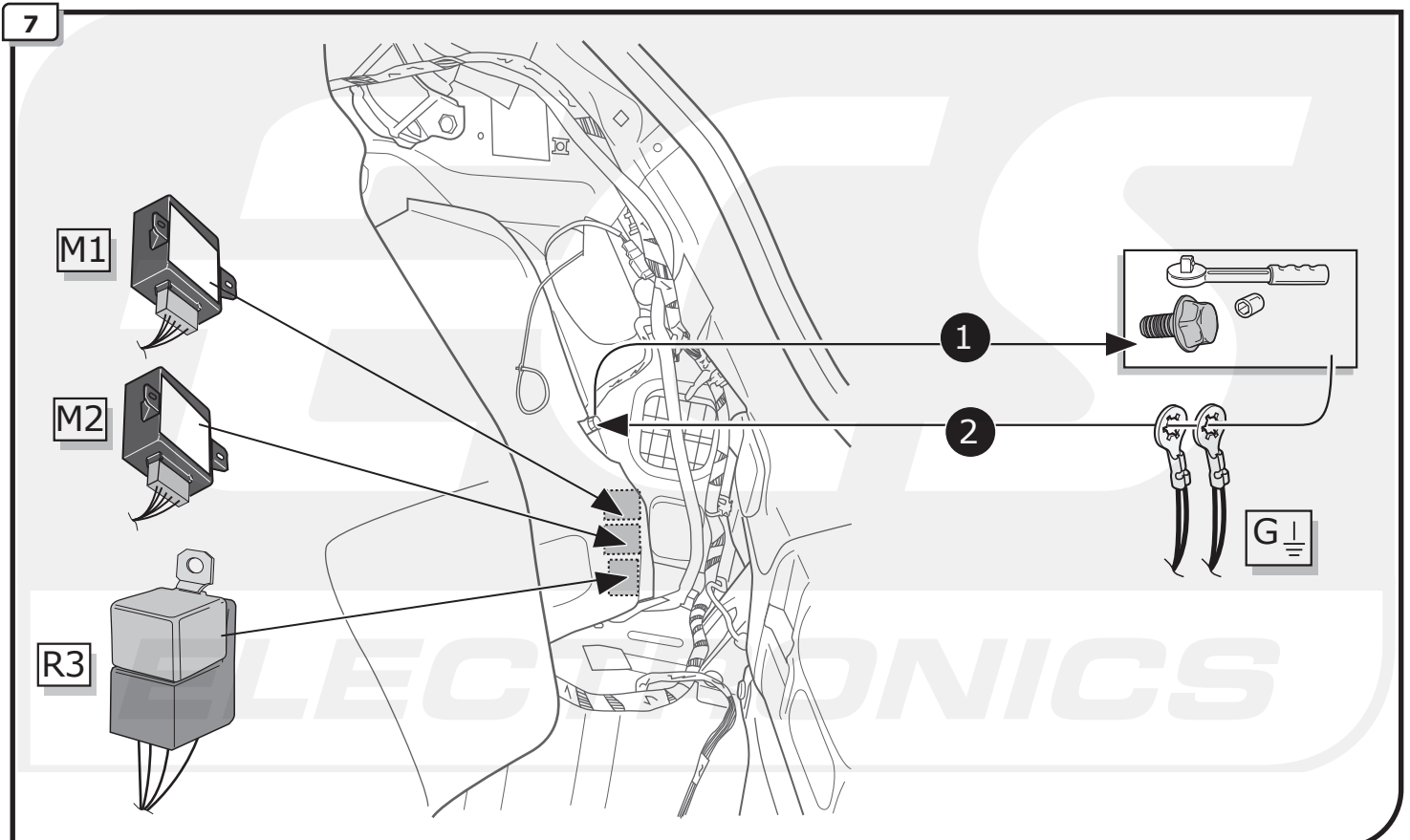
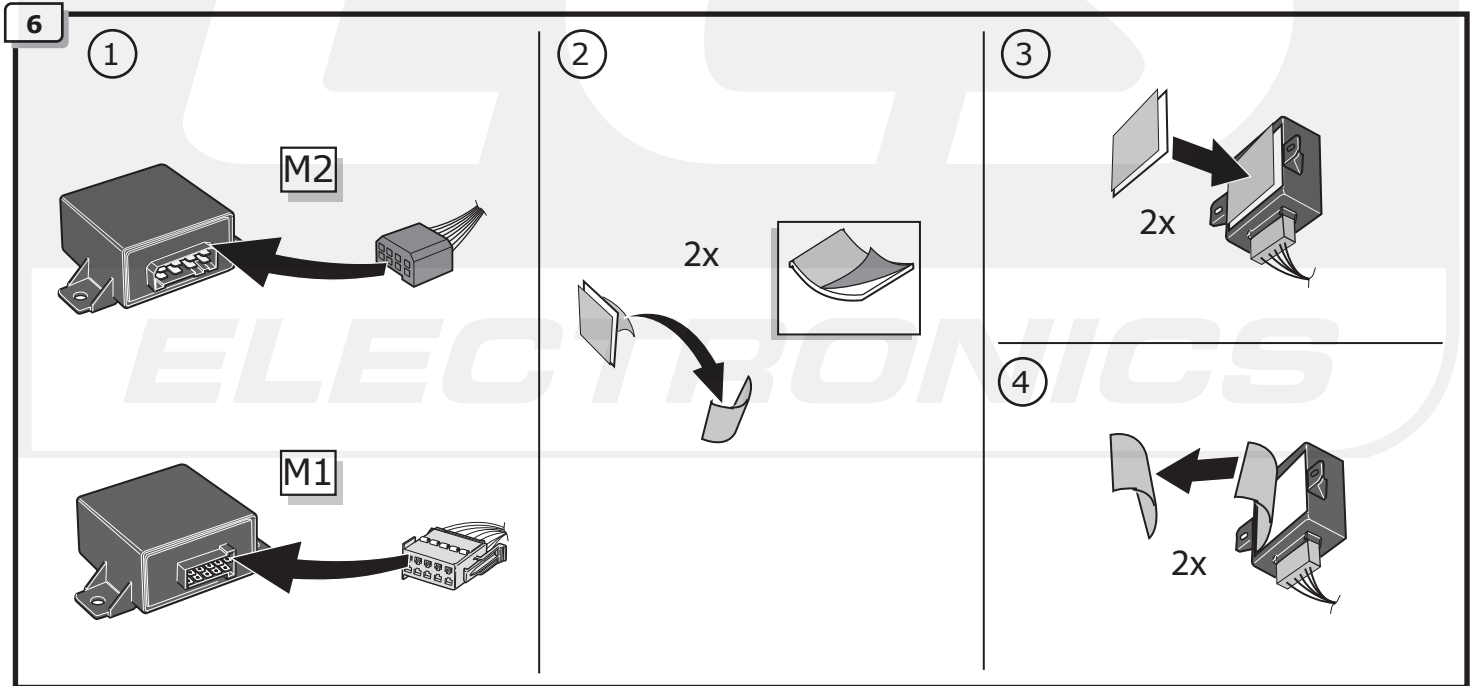
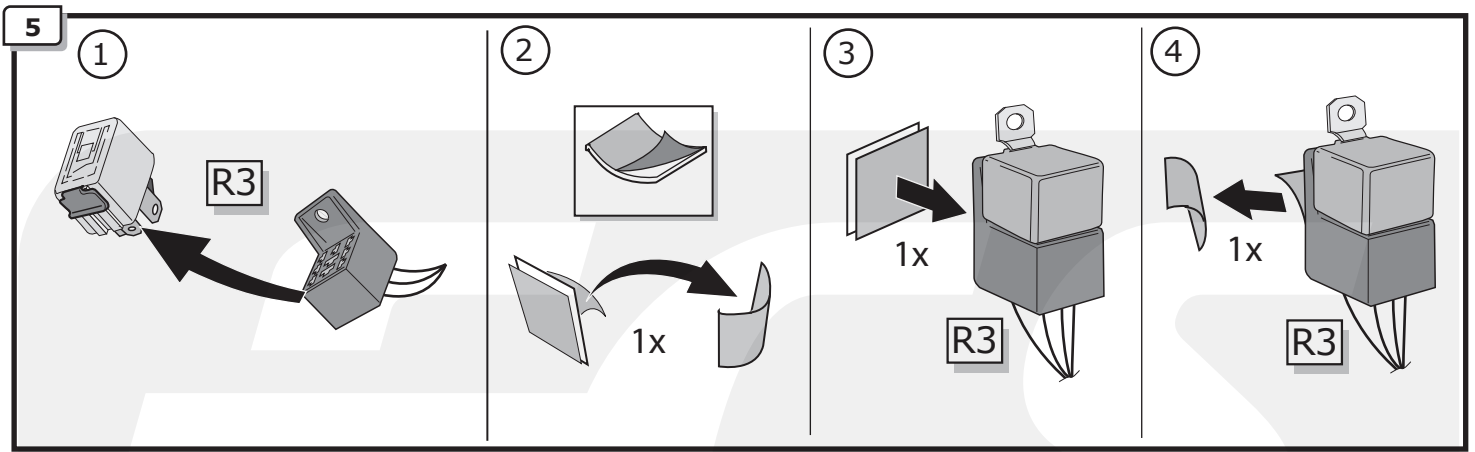

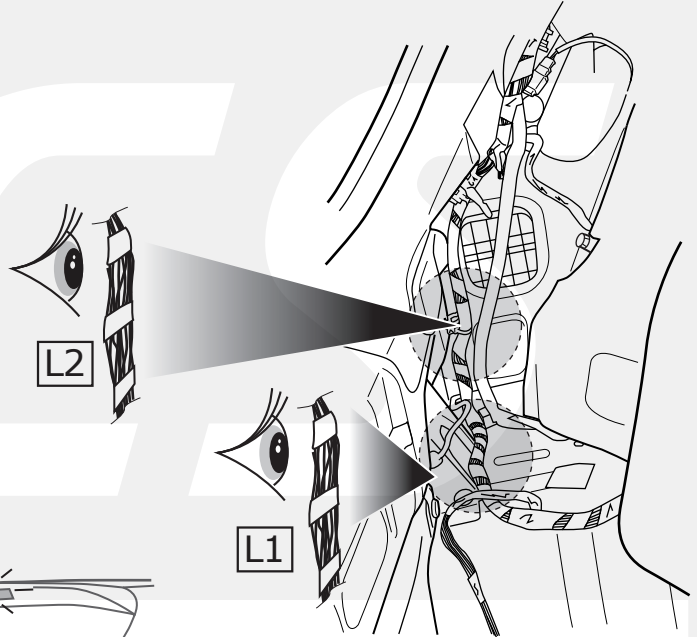
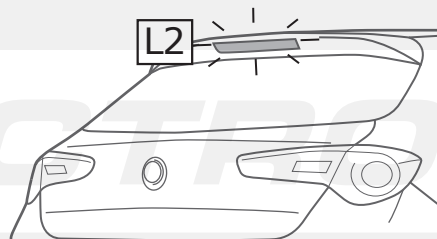
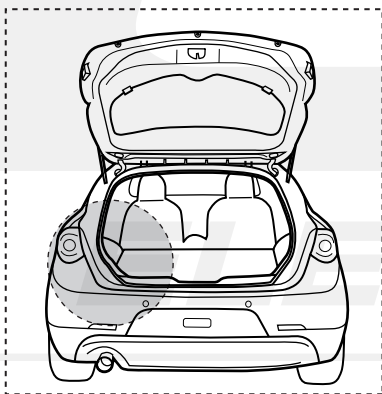
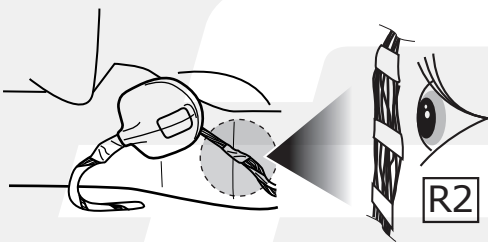
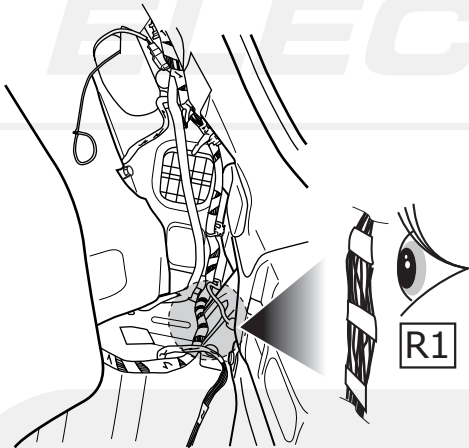
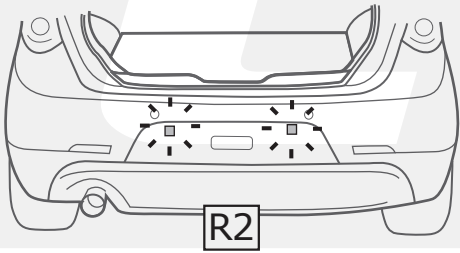
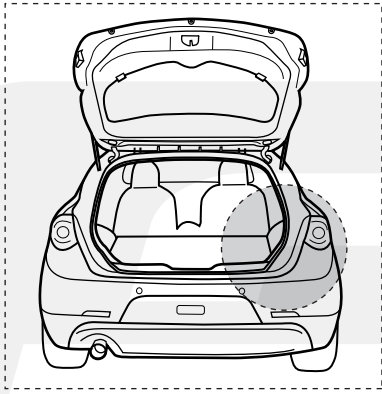

		(DE) Farben (FR) Couleurs (NL) Kleuren (GB) Colours (ES) Colores (IT) Colori (SE) Färgar	(CZ) Barevným (DK) Farverne (FI) Coloria (GR) χρώματα (NO) Farget (PL) Kolorować
R1	Reverse		
R1	R		
R1	R		
R2	58L+58R		YE / GY
L1	L		
L1	L		
L2	54		GN / BK

	● Farben ● Couleurs ● Kleuren ● Colours ● Colores ● Colori ● Färgar	● Barevným ● Färveme ● Coloria ● χρώματα ● Farget ● Kolorować
R1		
R1 R →		
R1 R 0#		
R2 SBL+5BR	YE / GY	
L1 L ←		
L1 L 0#		
L2 54	GN / BK	

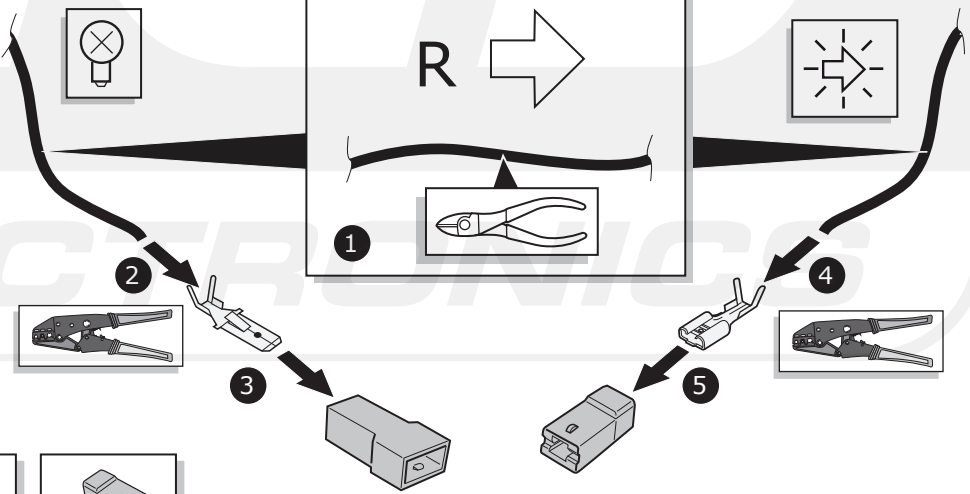
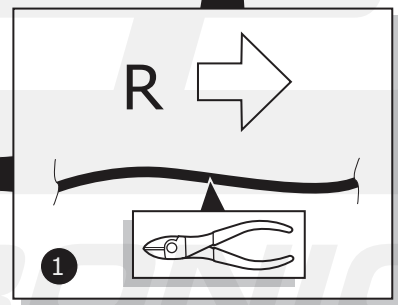
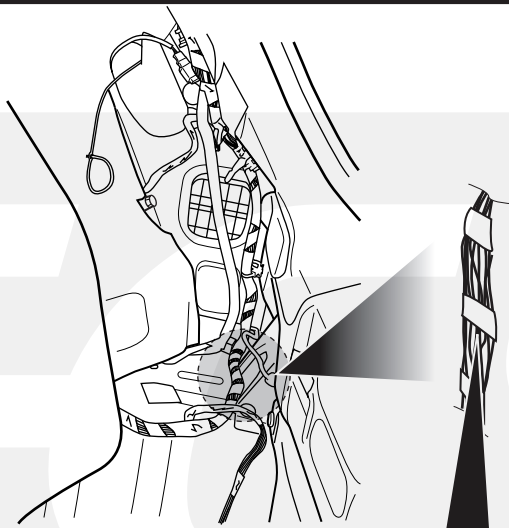

- 1x
- 1x
- 1x
- 1x

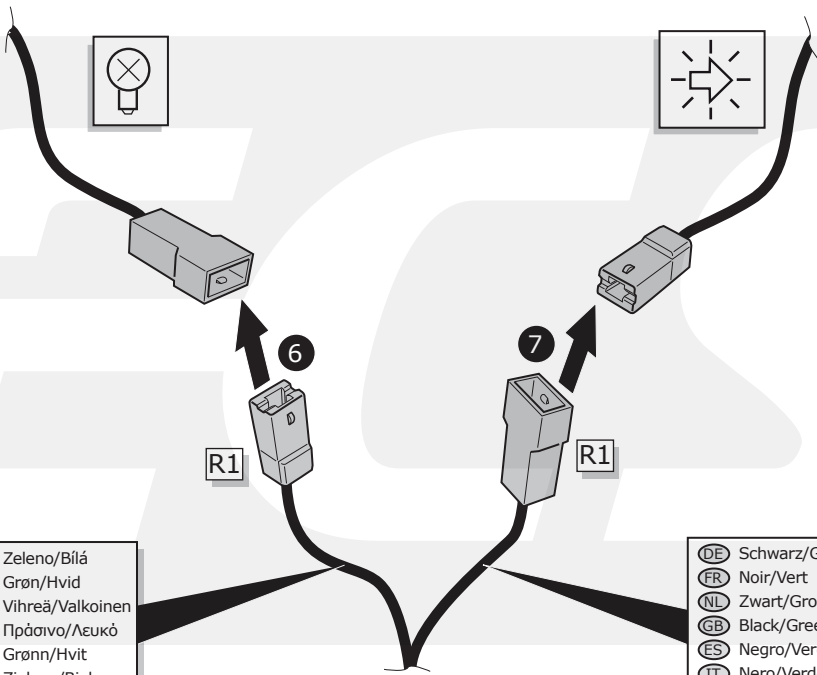

DE Grün/Weiß	CZ Zeleno/Bílá
FR Vert/Blanc	DK Grøn/Hvid
NL Groen/Wit	FI Vihreä/Valkoinen
GB Green/White	GR Πράσινο/Λευκό
ES Verde/Blanco	NO Grønn/Hvit
IT Verde/Bianco	PL Zielony/Biały
SE Grön/Vit	

DE Schwarz/Grün	CZ Černo/Zelená
FR Noir/Vert	DK Sort/Grøn
NL Zwart/Groen	FI Musta/Vihreä
GB Black/Green	GR Μαύρο/Πράσινο
ES Negro/Verde	NO Svart/Grønn
IT Nero/Verde	PL Czarny/Zielony
SE Svart/Grön	

	● Farben	○ Barevným
	● Couleurs	○ Farverne
	● Kleuren	○ Coloria
	● Colours	○ χρώματα
	● Colours	○ Färgar
	● Colori	○ Färgar
	● Färgar	○ Kolorować

R1		
R1	R →	
R1	R Ⓞ#	
R2	5BL+5BR	YE / GY
L1	L ←	
L1	L Ⓞ#	
L2	5L	GN / BK

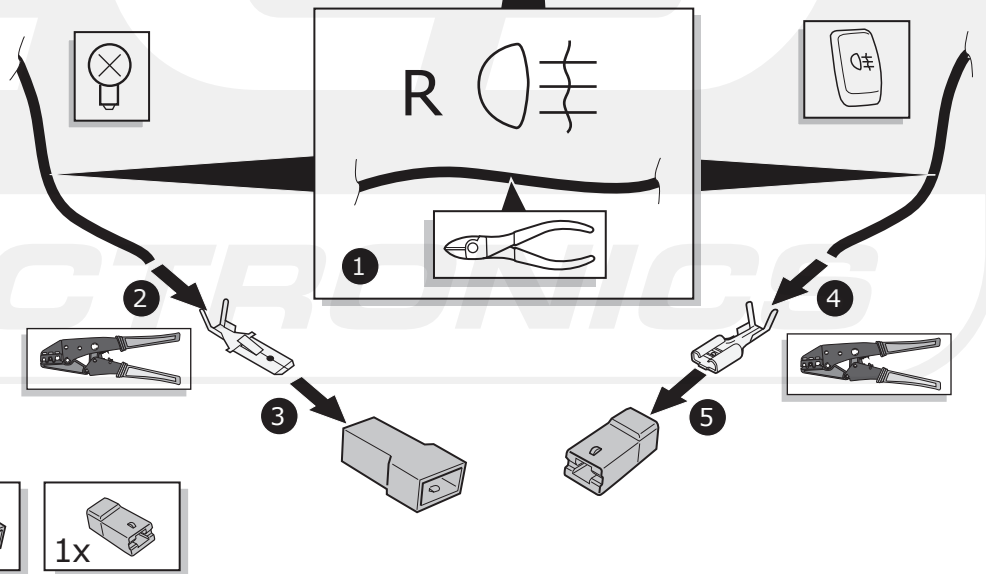
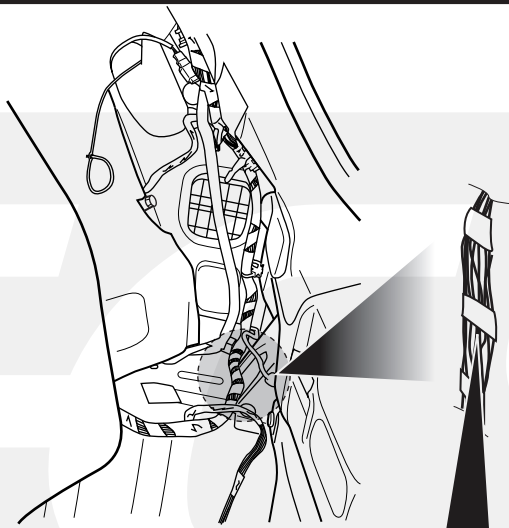

- 1x
- 1x
- 1x
- 1x

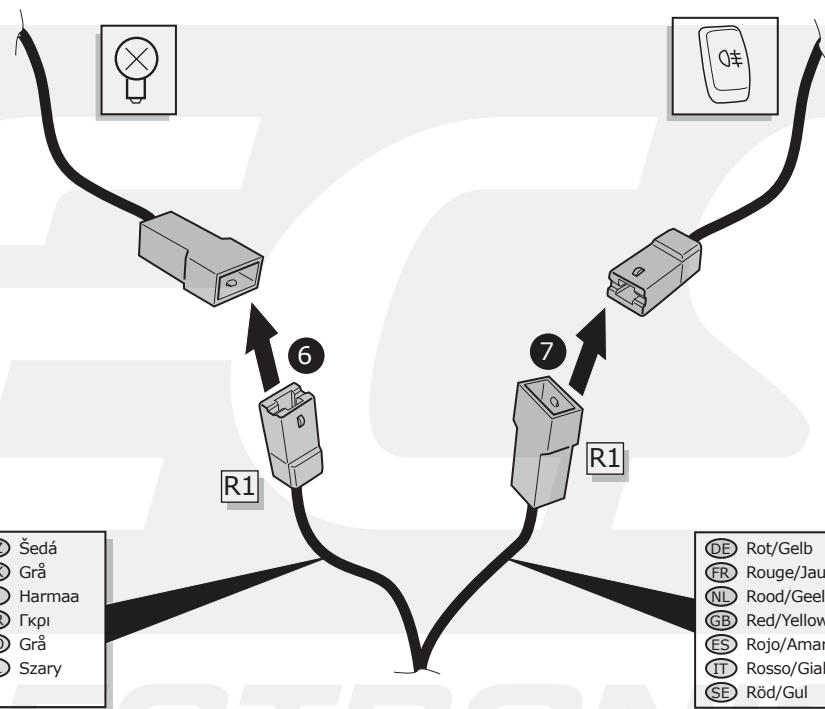

DE	Grau	CZ	Šedá
FR	Gris	DK	Grå
NL	Grijs	FI	Harmaa
GB	Grey	GR	Γκρι
ES	Gris	NO	Grå
IT	Grigio	PL	Szary
SE	Grå		

DE	Rot/Gelb	CZ	Červeno/Žlutá
FR	Rouge/Jaune	DK	Rød/Gul
NL	Rood/Geel	FI	Punainen/Keltainen
GB	Red/Yellow	GR	Κόκκινο/Κίτρινο
ES	Rojo/Amarillo	NO	Rød/Gul
IT	Rosso/Giallo	PL	Czerwony/Żółty
SE	Röd/Gul		

11

	<ul style="list-style-type: none"> ● Farben ● Couleurs ● Kleuren ● Colours ● Colores ● Colori ● Färgar 	<ul style="list-style-type: none"> ● Barevným ● Farverne ● Coloria ● χρώματα ● Farget ● Kolorowac
R1		
R1	R →	
R1	R Ⓞ#	
R2	SBL+58R	YE / GY
L1	L ←	
L1	L Ⓞ#	
L2	54	GN / BK

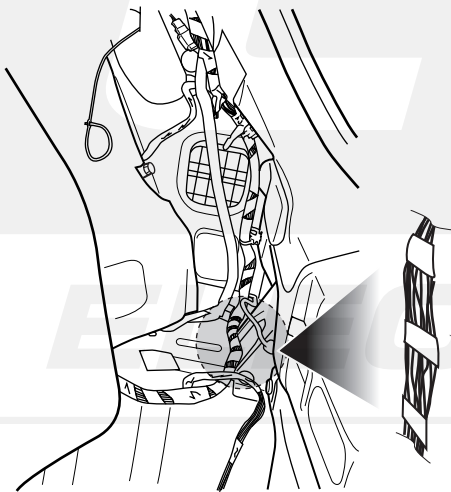
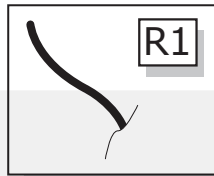
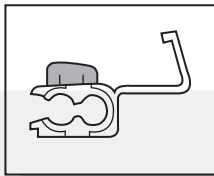

Reverse

2

1

DE Schwarz/Rot	CZ Černo/Červená
FR Noir/Rouge	DK Sort/Rød
NL Zwart/Rood	FI Musta/Punainen
GB Black/Red	GR Μαύρο/Κόκκινο
ES Negro/Rojo	NO Svart/Rød
IT Nero/Rosso	PL Czarny/Czerwony
SE Svart/Röd	

12

	<ul style="list-style-type: none"> ● Farben ● Couleurs ● Kleuren ● Colours ● Colores ● Colori ● Färgar 	<ul style="list-style-type: none"> ● Barevným ● Farverne ● Coloria ● χρώματα ● Farget ● Kolorowac
R1		
R1	R →	
R1	R Ⓞ#	
R2	SBL+58R	YE / GY
L1	L ←	
L1	L Ⓞ#	
L2	54	GN / BK

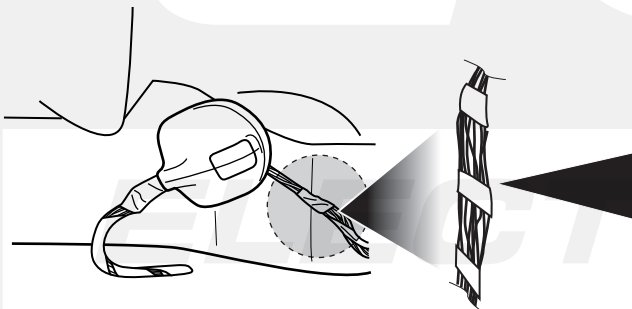
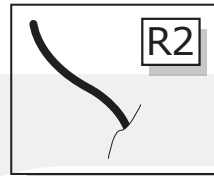
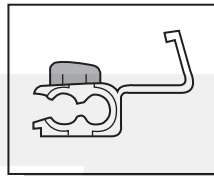























58L+58R



2

1

DE Schwarz/Braun	CZ Černo/Hnědá
FR Noir/Marron	DK Sort/Brun
NL Zwart/Bruin	FI Musta/Ruskea
GB Black/Brown	GR Μαύρο/Καφέ
ES Negro/Marrón	NO Svart/Brun
IT Nero/Marrone	PL Czarny/Brazowy
SE Svart/Brun	

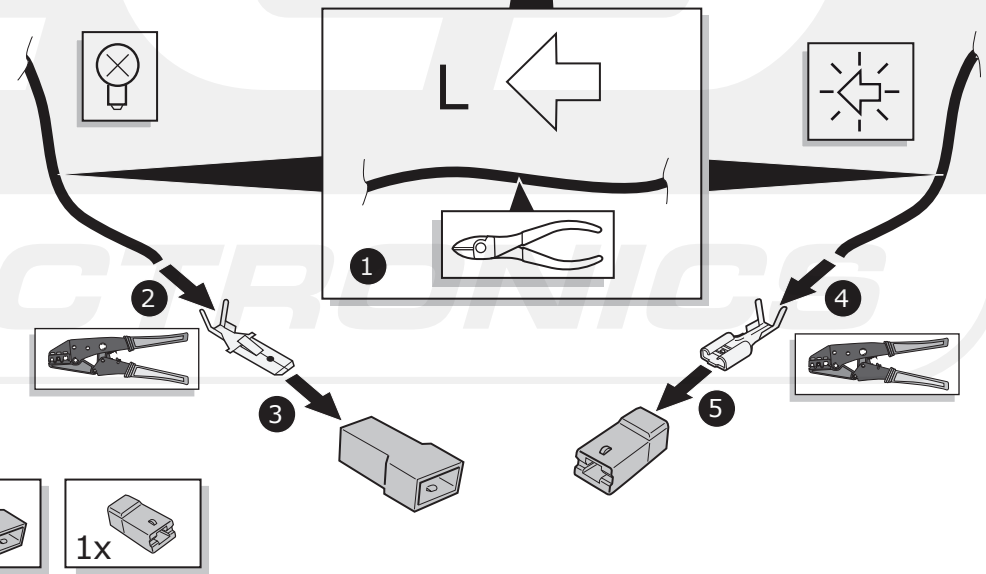
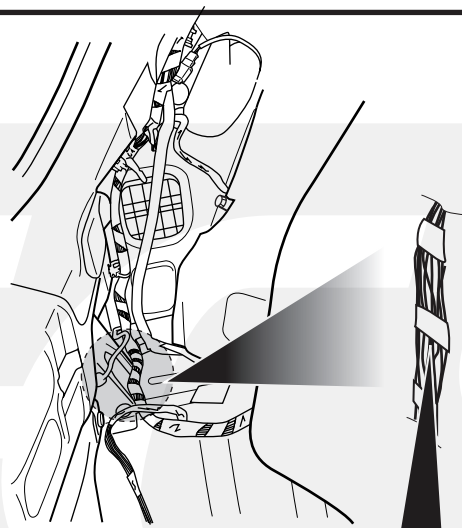
	<ul style="list-style-type: none"> ● Farben ● Couleurs ● Kleuren ● Colours ● Colores ● Colori ● Färgar 	<ul style="list-style-type: none"> ● Barevným ● Farverne ● Coloria ● χρώματα ● Färgjet ● Kolorować
R1 		
R1 	R 	
R1 	R 	
R2 SBL+ SBR 	YE / GY 	
L1 	L 	
L1 	L 	
L2 S4 	GN / BK 	

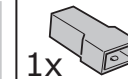
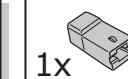

-  1x
-  1x
-  1x
-  1x

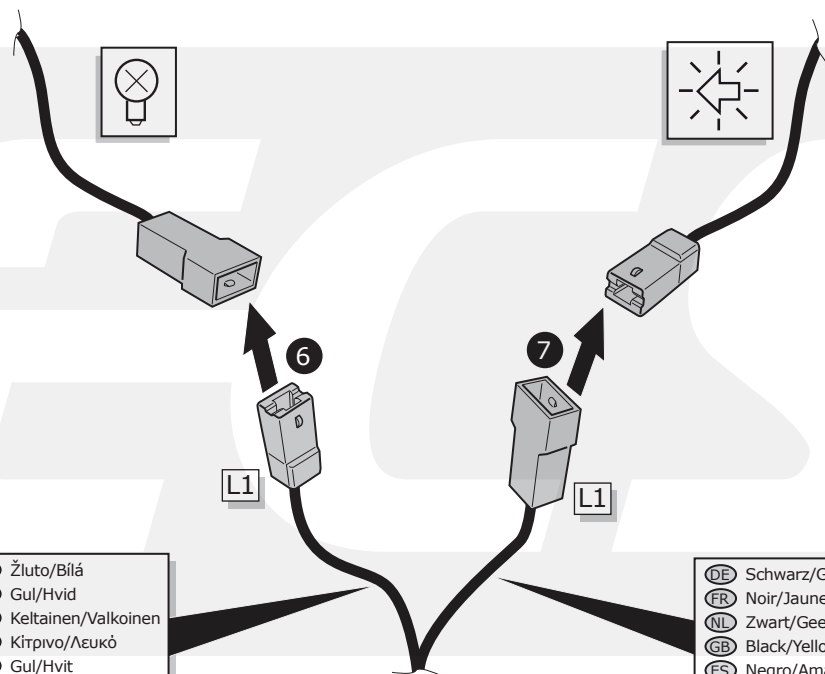

DE Gelb/Weiß	CZ Žluto/Bílá
FR Jaune/Blanc	DK Gul/Hvid
NL Geel/Wit	FI Keltainen/Valkoinen
GB Yellow/White	GR Κίτρινο/Λευκό
ES Amarillo/Blanco	NO Gul/Hvit
IT Giallo/Bianco	PL Żółty/Biały
SE Gul/Vit	

DE Schwarz/Gelb	CZ Černo/Žlutá
FR Noir/Jaune	DK Sort/Gul
NL Zwart/Geel	FI Musta/Keltainen
GB Black/Yellow	GR Μαύρο/Κίτρινο
ES Negro/Amarillo	NO Svart/Gul
IT Nero/Giallo	PL Czarny/Zółty
SE Svart/Gul	

	● Farben	● Barevným
	● Couleurs	● Farverne
	● Kleuren	● Coloria
	● Colours	● χρώματα
	● Colores	● Farget
	● Colori	● Kolorować
	● Färgar	
R1		
R1	R →	
R1	R Ⓞ#	
R2 5BL+5BR		YE / GY
L1	L ←	
L1	L Ⓞ#	
L2 5L		GN / BK

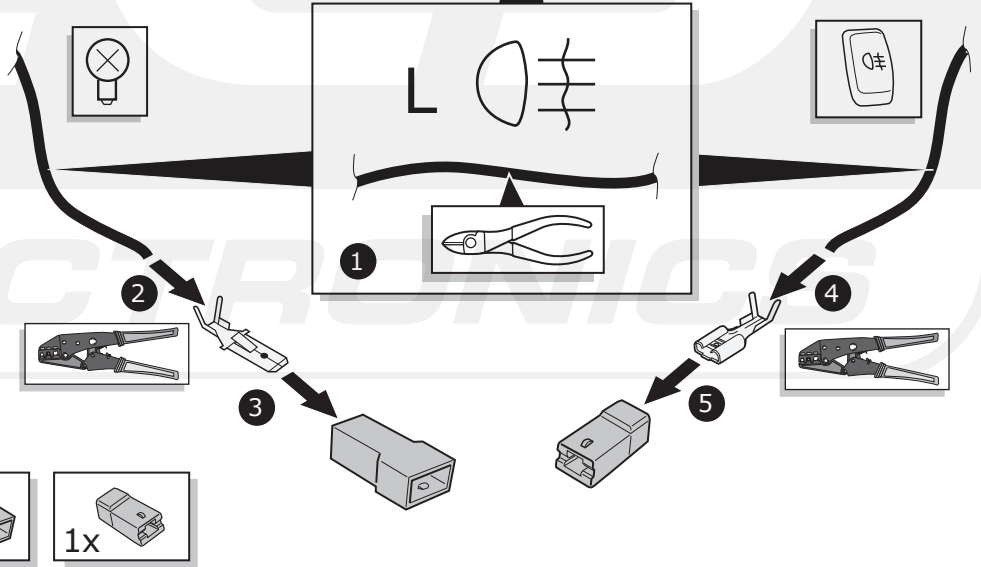
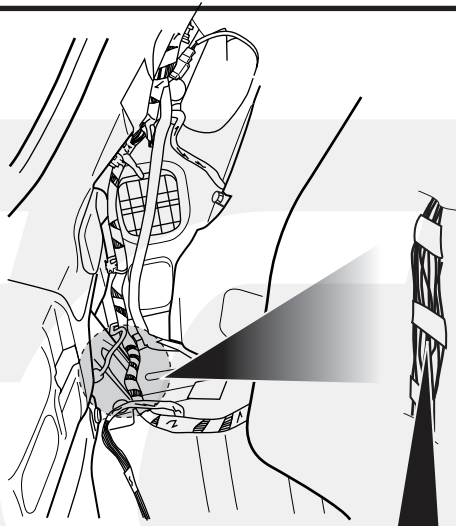

- 1x
- 1x
- 1x
- 1x

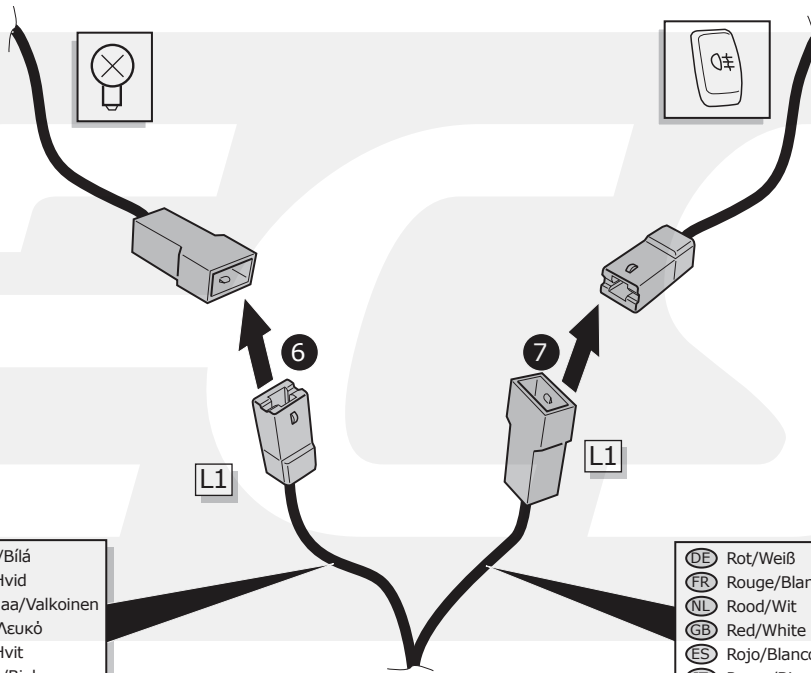

DE Grau/Weiß	CZ Šedo/Bílá
FR Gris/Blanc	DK Grå/Hvid
NL Grijs/Wit	FI Harmaa/Valkoinen
GB Grey/White	GR Γκρι/Λευκό
ES Gris/Blanco	NO Grå/Hvit
IT Grigio/Bianco	PL Szary/Biały
SE Grå/Vit	

DE Rot/Weiß	CZ Červeno/Bílá
FR Rouge/Blanc	DK Rød/Hvid
NL Rood/Wit	FI Punainen/Valkoinen
GB Red/White	GR Κόκκινο/Λευκό
ES Rojo/Blanco	NO Rød/Hvit
IT Rosso/Bianco	PL Czerwony/Biały
SE Röd/Vit	

15

	<ul style="list-style-type: none"> ● Farben ● Couleurs ● Kleuren ● Colours ● Colori ● Färgar 	<ul style="list-style-type: none"> ● Barevným ● Farverne ● Coloria ● xpoljeto ● Farget ● Kolorować
R1		
R1	R →	
R1	R 0#	
R2	5BL+5BR	YE / GY
L1	L ←	
L1	L 0#	
L2	54	GN / BK

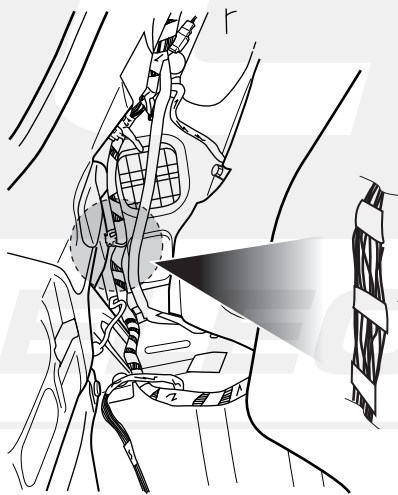
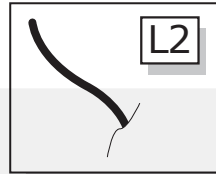
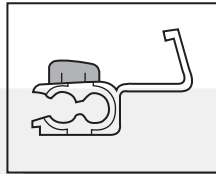

54 STOP

2

1

54 STOP

L2

DE	Blau/Rot	CZ	Modro/Červená
FR	Blue/Rouge	DK	Blå/Rød
NL	Blauw/Rood	FI	Sininen/Punainen
GB	Blue/Red	GR	Μπλε/Κόκκινο
ES	Azul/Rojo	NO	Blå/Rød
IT	Blu/Rosso	PL	Niebieski/Czerwony
SE	Blå/Röd		

16

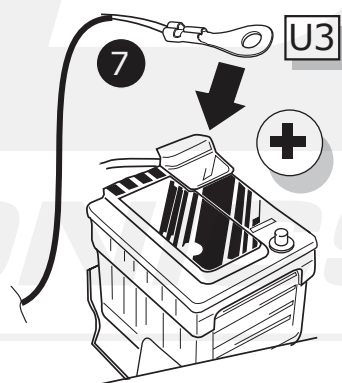
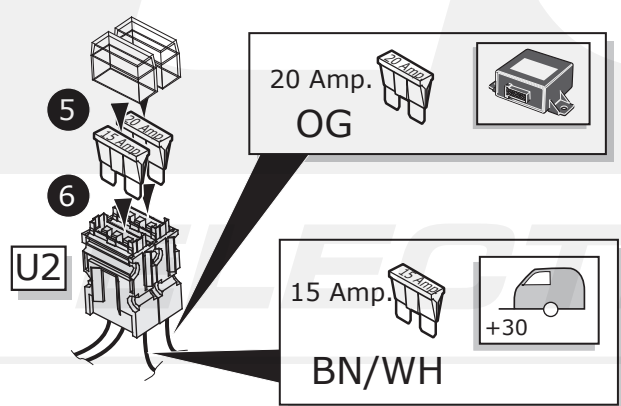
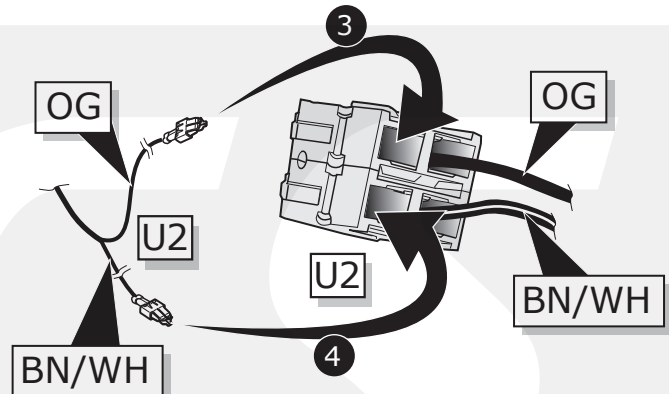
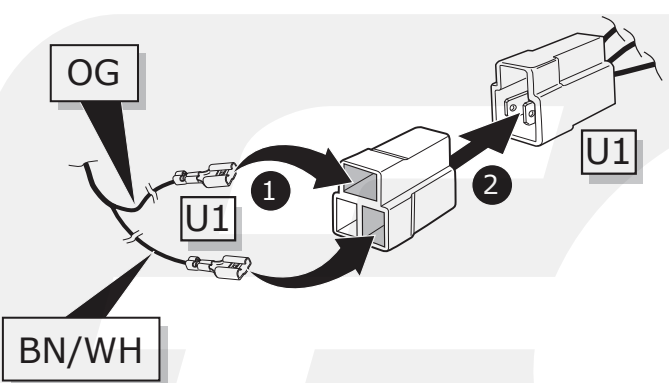

OPTION



DE	Braun	CZ	Hnědá
FR	Marron	DK	Brun
NL	Bruin	FI	Ruskea
GB	Brown	GR	Καφέ
ES	Marrón	NO	Brun
IT	Marrone	PL	Brązowy
SE	Brun		

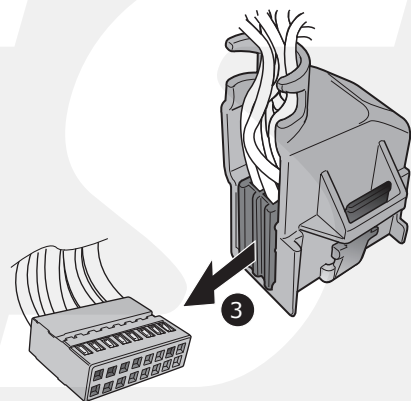
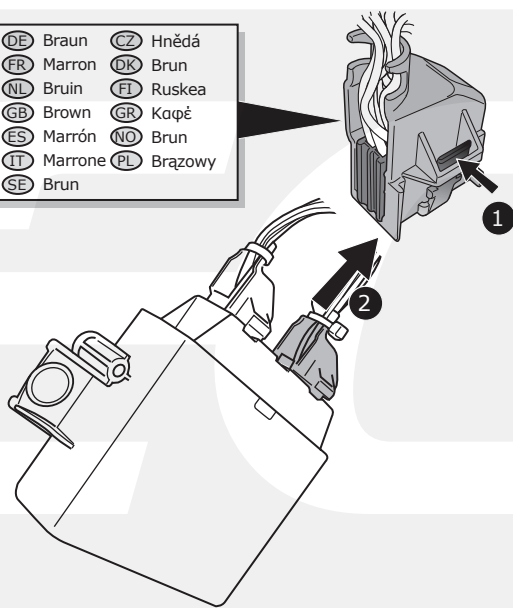
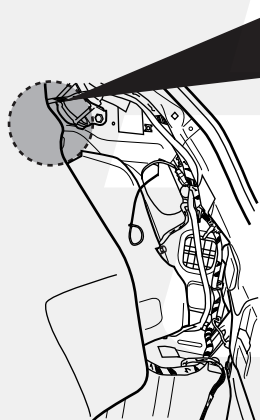

OPTION

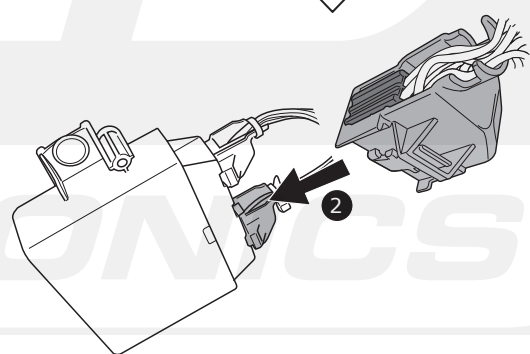
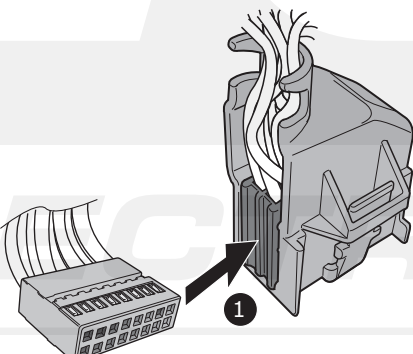
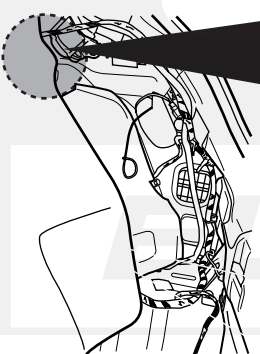
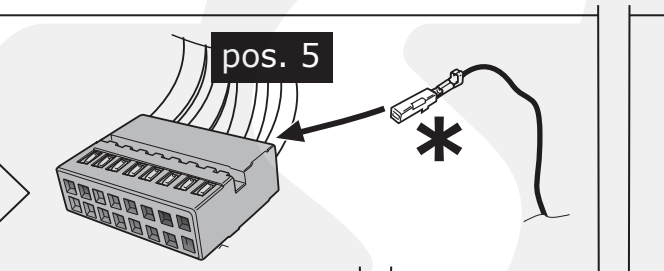
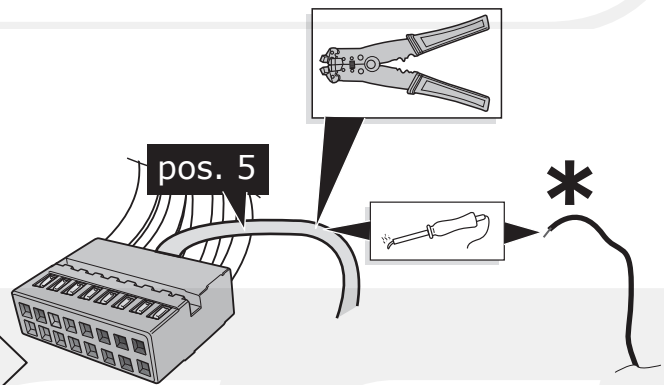
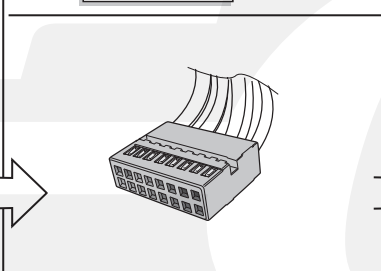
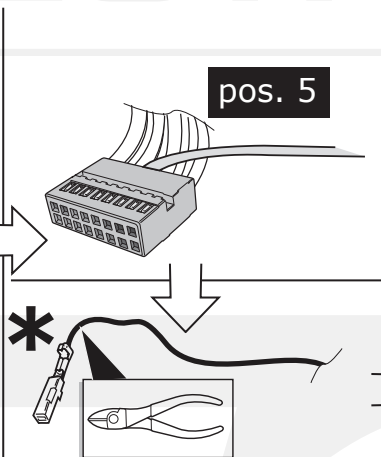
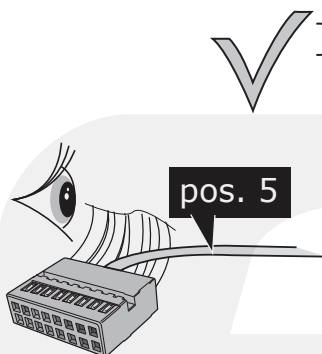
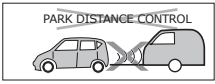

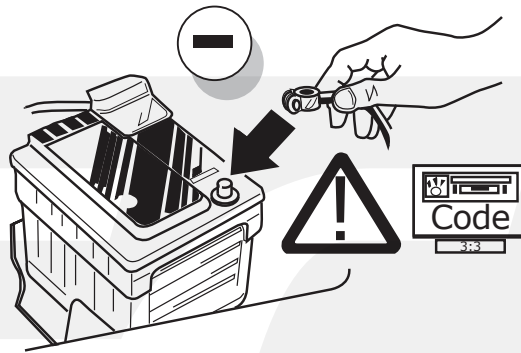

(DE) FUNKTIONEN KONTROLLIEREN MIT EINEM PRÜFGERÄT MIT WIDERSTAND ODER MIT LEUCHTEN MIT DER GENAUEN WATTZAHL!

(FR) CONTRÔLER LES FONCTIONS AVEC UNE BOÎTE DE TEST AVEC DE LA CHARGE OU DES LAMPES AVEC LA QUANTITÉ CORRECTE DE WATT!

(NL) CONTROLEER FUNCTIES MET EEN TESTER MET BELASTING OF LAMPEN MET DE JUISTE WATTAGE!

(GB) TEST ALL CIRCUIT FUNCTIONS WITH A TESTBOX WITH THE CORRECT POWER LOAD FOR EACH UNIT. A TESTBOX ON WHICH ONLY LEDs ARE USED CAN NOT BE USED IN THIS CASE

(ES) ¡CONTROLAR FUNCIONES CON UN TESTER CON CARGA O LUCES CON EL CORRECTO WATTAJE!

(IT) CONTROLLA FUNZIONI CON UN TESTER CON CARICO O LAMPADIE DEL GIUSTO WATT-TAGGIO!

(SE) KONTROLLERA FUNKTIONERNA MED EN TESTARE MED BELASTNING ELLER LAMPOR MED RÄTT WATT-VÄRDE!

(CZ) OVĚŘTE FUNKCE POMOČÍ TESTOVACÍHO BOXU NEBO SVĚTEL S PŘÍSLUŠNÝM VÝKONEM!

(DK) CHECK FUNKTIONERNE MED EN TESTBOKS, MED BELASTNING ELLER MED LYGTER MED DET KORREKTE ANTAL WATT!

(FI) TARKISTA TOIMINNOT KÄYTTÄMÄLLÄ TESTILAITE, JOSSA ON OIKEATEHOINEN KUORMITUS TAI OIKEATEHOISET LAMPUT!

(GR) ΕΛΕΓΞΤΕ ΤΙΣ ΛΕΙΤΟΥΡΓΙΕΣ ΜΕ ΈΝΑ ΚΙΒΩΤΙΟ ΔΟΚΙΜΗΣ ΜΕ ΦΟΡΤΙΟ Ή ΛΑΜΠΗΡΕΣ ΣΩΣΤΗΣ ΠΟΣΟΤΗΤΑΣ ΒΑΤ!

(NO) KONTROLER FUNKSJONENE MED EN TESTER MED BELASTNING ELLER LYSPÆRER MED RIKTIG WATTVERDI!

(PL) SPRAWDŹ FUNKCJE UŻYWAJĄC SKRZYŃKI TESTOWEJ Z OBCIĄŻENIEM LUB PODŁĄCZONYMI ŻARÓWKAMI O ODPOWIEDNIEJ MOCY!

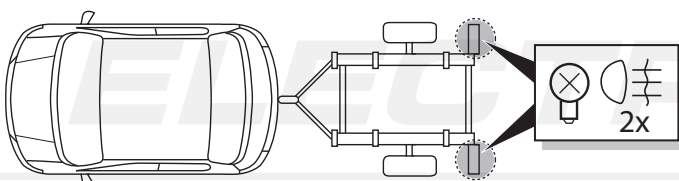
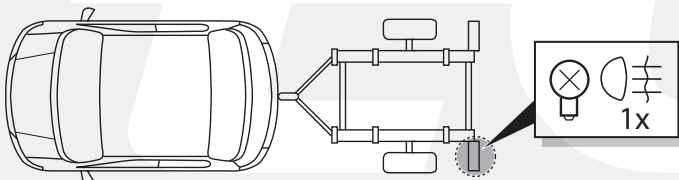
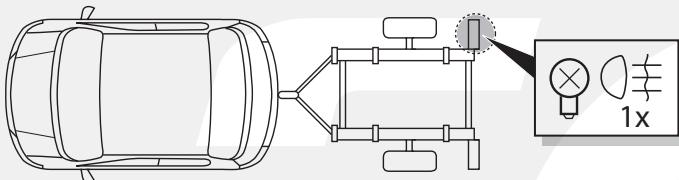

INFO

- | | |
|----------------------------------|--------------------------------------|
| (DE) Einzelteile wieder einbauen | (CZ) Znovu zasuňte obložení |
| (FR) Montez les part enlevées | (DK) Påsæt beklædningen |
| (NL) Terug plaatsen onderdelen | (FI) Asenna verhoilut takaisin |
| (GB) Reinstall linings | (GR) Τοποθετήστε ξανά τις επενδύσεις |
| (ES) Reinstalar componentes | (NO) Sett tilbake deler |
| (IT) Rimetti a posto componenti | (PL) Założyć wykładzinę |
| (SE) Sätt tillbaka delar | |

22

- | |
|-----------------------------|
| (DE) Gebrauchsanleitung. |
| (FR) Mode d'emploi. |
| (NL) Gebruikershandleiding. |
| (GB) User guide. |
| (ES) Guía del usuario. |
| (IT) Manuale di istruzioni. |
| (SE) Bruksanvisning. |
| (CZ) Uživatelská příručka. |
| (DK) Brugervejledning. |
| (FI) Käyttöohjeet. |
| (GR) Οδηγός χρήστη. |
| (NO) Brukerveiledning. |
| (PL) Instrukcja obsługi. |

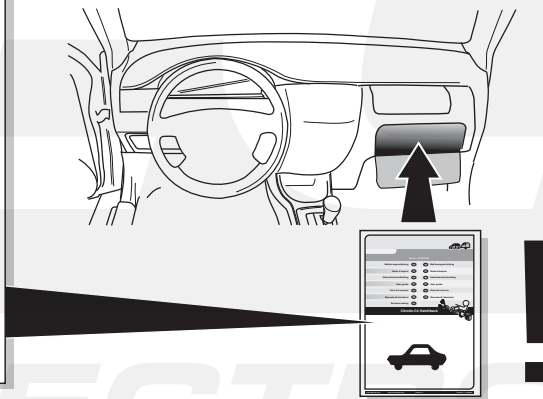

00800
CALL2ECS
22 55 23 27

09.00 - 18.00
 Monday - Friday

www.ecs-electronics.nl

ECS

ELECTRONICS

- (DE) Anschluss Steckdose (ES) Conexión de la caja de enchufe (CZ) Objímkový konektor (GR) Υποδοχή σύνδεσης
 (FR) Connection de la prise (IT) Allaccio zoccolo (DK) Stikdåse forbindelse (NO) Tilkobling koblingsboks
 (NL) Contactdoos aansluiting (SE) Anslutning kontaktdosa (FI) Pistorasia liitäntä (PL) Połączenie przez gniazdo
 (GB) Socket connection

DIN/ISO 11446		1-8		5/58-R		6/54		7/58-L		30+ 15+ 15+	10	10	9	10	11	12	9
Pmax	21W	3/31	4/R	52W	3x21W	6/54	52W	7/58-L	2x21W	180W/15Amp	180W/15Amp	180W/15Amp	180W/15Amp	180W/15Amp	180W/15Amp	180W/15Amp	180W/15Amp
(DE)	Gelb	Weiß	Grün	Braun	Rot (1,00mm ²)	Rot (1,00mm ²)	Schwarz	Schwarz	Schwarz/ Rot	Braun/ Weiß	Rot (2,50mm ²)	Weiß	Rot/ Blau	Rot/ Blau	Rot/ Blau	Rot/ Blau	Weiß
(FR)	Jaune	Blanc	Vert	Marron	Rouge (1,00mm ²)	Rouge (1,00mm ²)	Noir	Noir	Noir/ Rouge	Marron/ Blanc	Rouge (2,50mm ²)	Blanc	Rouge/ Bleu	Rouge/ Bleu	Rouge/ Bleu	Rouge/ Bleu	Blanc
(NL)	Geel	Wit	Groen	Bruin	Rood (1,00mm ²)	Rood (1,00mm ²)	Zwart	Zwart	Zwart/ Rood	Bruin/ Wit	Rood (2,50mm ²)	Wit	Rood/ Blauw	Rood/ Blauw	Rood/ Blauw	Rood/ Blauw	Wit
(GB)	Yellow	White	Green	Brown	Red (1,00mm ²)	Red (1,00mm ²)	Black	Black	Black/ Red	Brown/ White	Red (2,50mm ²)	White	Red/ Blue	Red/ Blue	Red/ Blue	Red/ Blue	White
(ES)	Amarillo	Blanco	Verde	Marrón	Rojo (1,00mm ²)	Rojo (1,00mm ²)	Negro	Negro	Negro/ Rojo	Marrón/ Blanco	Rojo (2,50mm ²)	Blanco	Rojo/ Azul	Rojo/ Azul	Rojo/ Azul	Rojo/ Azul	Blanco
(IT)	Giallo	Bianco	Verde	Marrone	Rosso (1,00mm ²)	Rosso (1,00mm ²)	Nero	Nero	Nero/ Rosso	Marrone/ Bianco	Rosso (2,50mm ²)	Bianco	Rosso/ Blu	Rosso/ Blu	Rosso/ Blu	Rosso/ Blu	Bianco
(SE)	Gul	Vit	Grön	Brun	Röd (1,00mm ²)	Röd (1,00mm ²)	Svart	Svart	Svart/ Röd	Brun/ Vit	Röd (2,50mm ²)	Vit	Röd/ Blå	Röd/ Blå	Röd/ Blå	Röd/ Blå	Vit
(CZ)	Žlutá	Bílá	Zelená	Hnědá	Červená (1,00mm ²)	Červená (1,00mm ²)	Černá	Černá	Černo/ Červená	Hnědo/ Bílá	Červená (2,50mm ²)	Bílá	Červená/ Modrá	Červená/ Modrá	Červená/ Modrá	Červená/ Modrá	Bílá
(DK)	Gul	Hvid	Grøn	Brun	Rød (1,00mm ²)	Rød (1,00mm ²)	Sort	Sort	Sort/ Rød	Brun/ Hvid	Rød (2,50mm ²)	Hvid	Rød/ Blå	Rød/ Blå	Rød/ Blå	Rød/ Blå	Hvid
(FI)	Keltainen	Valkoinen	Vihreä	Ruskea	Punainen (1,00mm ²)	Punainen (1,00mm ²)	Musta	Musta	Musta/ Punainen	Ruskea/ Valkoinen	Punainen (2,50mm ²)	Valkoinen	Punainen/ Sininen	Punainen/ Sininen	Punainen/ Sininen	Punainen/ Sininen	Valkoinen
(GR)	Κίτρινο	Λευκό	Πράσινο	Καφέ	Κόκκινο (1,00mm ²)	Κόκκινο (1,00mm ²)	Μαύο	Μαύο	Μαύο/ Κόκκινο	Καφέ/ Λευκό	Κόκκινο (2,50mm ²)	Λευκό	Κόκκινο/ Μπλε	Κόκκινο/ Μπλε	Κόκκινο/ Μπλε	Κόκκινο/ Μπλε	Λευκό
(NO)	Gul	Hvit	Grønn	Brun	Rød (1,00mm ²)	Rød (1,00mm ²)	Svart	Svart	Svart/ Rød	Brun/ Hvit	Rød (2,50mm ²)	Hvit	Rød/ Blå	Rød/ Blå	Rød/ Blå	Rød/ Blå	Hvit
(PL)	Żółty	Biały	Zielony	Brazowy	Czerwon (1,00mm ²)	Czerwon (1,00mm ²)	Czarny	Czarny	Czarny/ Czerwon	Brazowy/ Biały	Czerwon (2,50mm ²)	Biały	Czerwon/ Niebieski	Czerwon/ Niebieski	Czerwon/ Niebieski	Czerwon/ Niebieski	Biały