

Alfa Romeo Giulietta

Partnr.: AF-011-BH

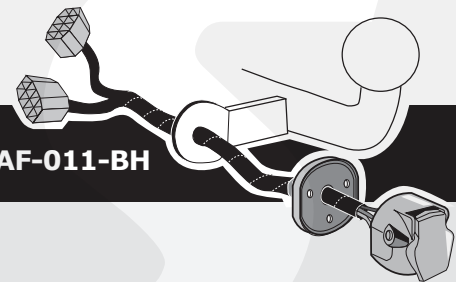

DE Einbauanleitung Elektrosatz Anhängervorrichtung mit 12-N Steckdose It. DIN/ISO Norm 1724.

FR Instructions de montage du faisceau électrique pour crochet d'attelage conforme à la norme DIN/ISO 1724 prise 12-N

NL Montage-handleiding elektrokabelset voor trekhaak met 12-N contactdoos vlg. DIN/ISO norm 1724.

GB Fitting instructions electric wiring kit tow bar with 12-N socket up to DIN/ISO Norm 1724.

ES Instrucciones de montaje de kit eléctrico para engancho de remolque con caja de conexiones 12-N según norma DIN/ISO 1724.

IT Istruzioni di montaggio di set di cavi elettrici per gancio da traino con zoccolo a 12 N conforme alla norma DIN/ISO 1724.

SE Monteringsanvisningar elkabelsats för dragkrok med 12-N kontaktdosa enligt DIN/ISO norm 1724.

CZ Montážní pokyny: souprava pro elektrické propojení tažné tyče s 12 - N zásuvkou do normy DIN/ISO 1724.

DK Monteringsvejledninger for det elektriske ledningsføringssæt for trækstang med 12-N stikdåse, DIN/ISO, norm 1724.

FI Ohjeet vetokoukun sähkökaapelisarjan asentamiseen, jossa on DIN/ISO 1724 mukainen 12-N liitin.

GR Οδηγίες συναρμολόγησης ηλεκτρικού σετ καλωδίων μπάρας ρυμούλκησης με υποδοχή 12-N μέχρι DIN/ISO Κανόνας 1724.

NO Monteringsanviser elkabelsett for trekrok med 12-N koblingsboks ifølge DIN/ISO norm 1724.

PL Instrukcje montażu zestawu okablowania elektrycznego dyszla holowniczego z 12-N stykowym gniazdem DIN/ISO 1724.

DE - Wir weisen ausdrücklich darauf hin, dass eine unsachgemäße und nicht in einer Fachwerkstatt durchgeführte Montage einen Verzicht auf Entschädigung jeglicher Art insbesondere bezüglich des Produkthaftpflichtrechts zur Folge hat

FR - Il est expressément prévu qu' on ne saurait se prévaloir d'un quelconque préjudice contractuel ou réhibitoire si le montage avait été fait en dépit des dites instructions ou dans un garage ne disposant pas des équipements adéquats.

NL - Wij wijzen er met nadruk op, dat ondeskundige en niet door een vakkundige werkplaats uitgevoerde montage tot gevolg heeft dat daardoor ieder recht op schadevergoeding, ook op wettelijke aansprakelijkheid inzake producten, vervalt.

GB - We would expressly point out that assembly not carried out properly by a competent installer will result in cancellation of any right to damage compensation, in particular those arising by virtue of the product liability act.

ES - El montaje inapropiado y efectuado por personal no cualificado originará la pérdida de todo derecho a indemnización o la expiración de toda responsabilidad civil con respecto al producto.

IT - Sottolineiamo espressamente che un montaggio inadeguato ed eseguito da un'officina non specializzata ha come conseguenza il decadere di qualsiasi diritto al risarcimento danni, nonché alla responsabilità legale relativa ai prodotti.

SE - Vi påpekar med eftertryck att all rätt till skadeersättning och all laglig ansvarighet förfaller om monteringen inte har utförts på rätt sätt och av en professionell verkstad.

CZ - Výslovně zdůrazňujeme, že jakákoli montáž, která není provedená ve specializované dílně, má za následek odvolání nároků na kompenzaci jakéhokoliv druhu, obzvláště vyplývajících ze zákona o odpovědnosti za způsobené škody.

DK - Vi ønsker at gøre udtrykkeligt opmærksom på at forkert samling, der ikke er udført af et specialiseret værksted, resulterer i bortfaldelse af kompenseringskrav af alle slags, i særdeles krav der måtte opstå omkring det lovpligtige ansvar.

FI - Korostamme, että kaikki oikeudet vahinkokorvaukseen kuten myös valmistajan laillinen vastuu raukeavat, mikäli asennusta ei ole toteutettu oikealla tavalla eikä ammattitaitoisen asiantuntijan toimesta.

GR - Επισημαίνουμε κατηγορηματικά ότι οποιαδήποτε εσφαλμένη συναρμολόγηση, η οποία δεν έχει πραγματοποιηθεί ειδικό εργαστήριο θα οδηγήσει σε απονομή των αξιώσεων επιβολής αποζημιώσεων οποιαδήποτε είδους, ειδικά όσα προκύπτουν από το νόμο ευθύνης προϊόντων.

NO - Vi påpeker ettertrykkelig at all rett til skadeerstatning og rettslig ansvar forfaller dersom monteringen ikke er blitt utført på riktig måte og av et profesjonelt verksted.

PL - Chcielibyśmy wyraźnie zaznaczyć, iż wszelki nieprawidłowy montaż, który nie jest wykonywany w specjalistycznym warsztacie pociąga za sobą utratę możliwości dochodzenia wszelkiego typu roszczeń, w szczególności tych wynikających z odpowiedzialności producenta za swój produkt.

- Technische Änderungen vorbehalten.
- Widerstand nur gemäß der Tabelle auf dem Anhänger verwenden.

- Sous réserve de modifications techniques.
- Ne excédez pas la charge maximale, indiquée dans le tableau.

- Technische wijzigingen voorbehouden.
- Gebruik alleen belasting volgens aansluittabel op het getrokken voertuig.

- Contents of these kits and their fitting manuals are subject to alteration without notice, please ensure that these instructions are read and fully understood before commencing installation.
- Do not overload circuits; the maximum loads per connection are detailed in this manual.

- Nos reservamos el derecho a efectuar modificaciones técnicas.
- Utilice sólo cargas de acuerdo a la tabla de conexión del vehículo remolcado.

- Ci si riserva il diritto di apportare modifiche tecniche.
- Utilizzare esclusivamente un carico conforme alla tabella degli allacci relativa al veicolo in questione.

- Tekniska ändringar förbehålles.
- Använd endast belastning enligt anslutningstabellen på det dragna fordonet.

- Změny mohou být provedeny bez oznámení.
- Používejte pouze při maximálním nabití podle tabulky na tažném vozidle.

- Kan ændres uden varsel.
- Brug kun den maksimale belastning, i overensstemmelse med forbindelsestabelen for bugserede køretøjer.

- Oikeus teknisiin muutoksiin ilman erillistä huomautusta pidetään.
- Kuormita työvirtapiiriä ainoastaan hinattavan ajoneuvon kytkentäkaavion mukaisesti.

- Μπορεί να τροποποιηθεί χωρίς προηγούμενη ειδοποίηση.
- Χρησιμοποιείτε μόνο μέγιστο ηλεκτρικό φορτίο σύμφωνα με τον πίνακα σύνδεσης στο ρυμούλκούμενο όχημα.

- Tekniske endringer forbeholdes. - Overskrid ikke grensene anviset i tilkoblingstabellen på tilhengeren eller det tilkoblede kjøretøyet.

- Podlega zmianom bez powiadomienia.
- Używać tylko takiego maksymalnego obciążenia które wynika z tabliczki połączeń holowanego pojazdu.

Einzelteilliste

Liste de pièces

Onderdelenlijst

Part list

Lista de componentes

Elenco componenti

Dellista

Seznam dílů

Del-liste

Osaluettelo

Κατάλογος εξαρτημάτων

Delliste

Lista części

(DE)

(FR)

(NL)

(GB)

(ES)

(IT)

(SE)

(CZ)

(DK)

(FI)

(GR)

(NO)

(PL)

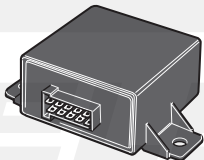
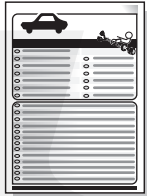
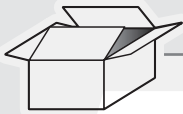

M1

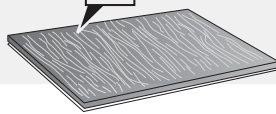

3x



5x

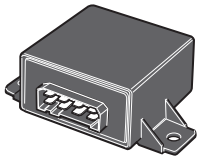

M2

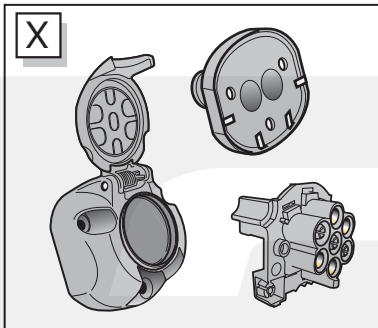

X

*** OPTION P.D.C.**

PARK DISTANCE CONTROL

↓

PARK DISTANCE CONTROL

→ **Pag. 5**

→ **Pag. 13-14**

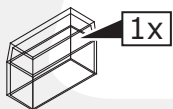
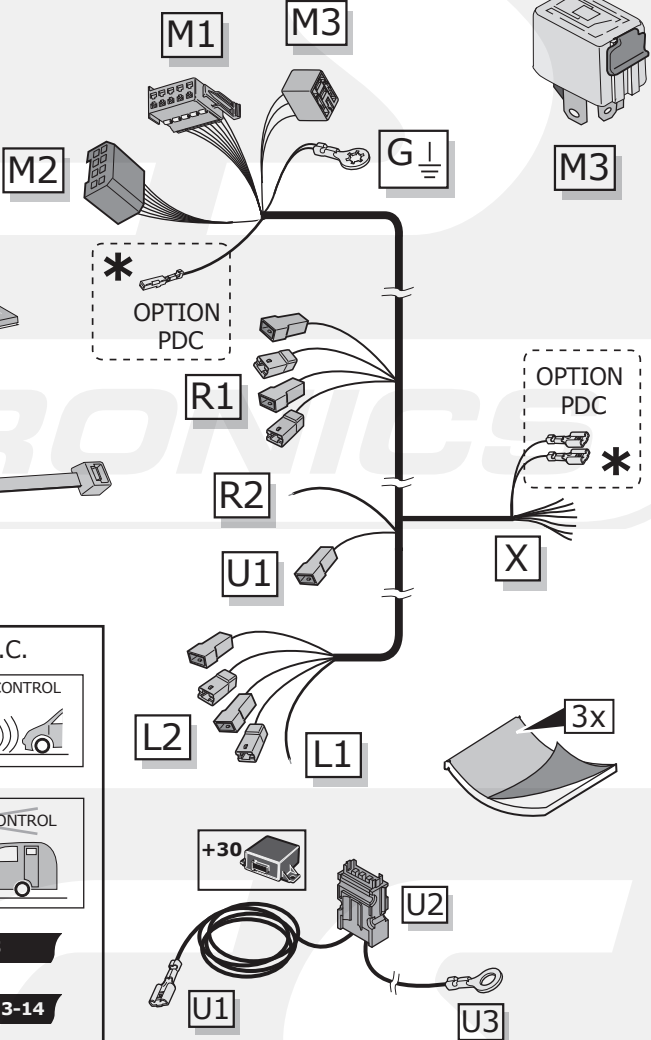

1x

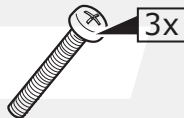

3x



4x

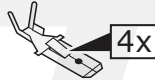

4x



1x

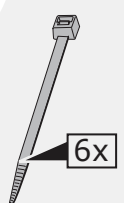

6x

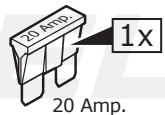

1x

20 Amp.



3x

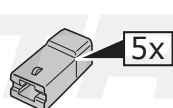

5x



4x

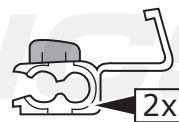

2x

ROUTING

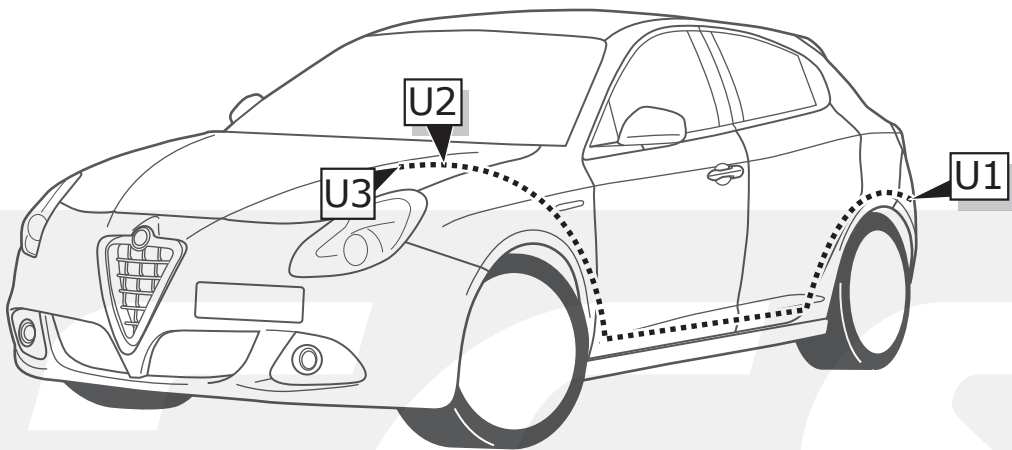
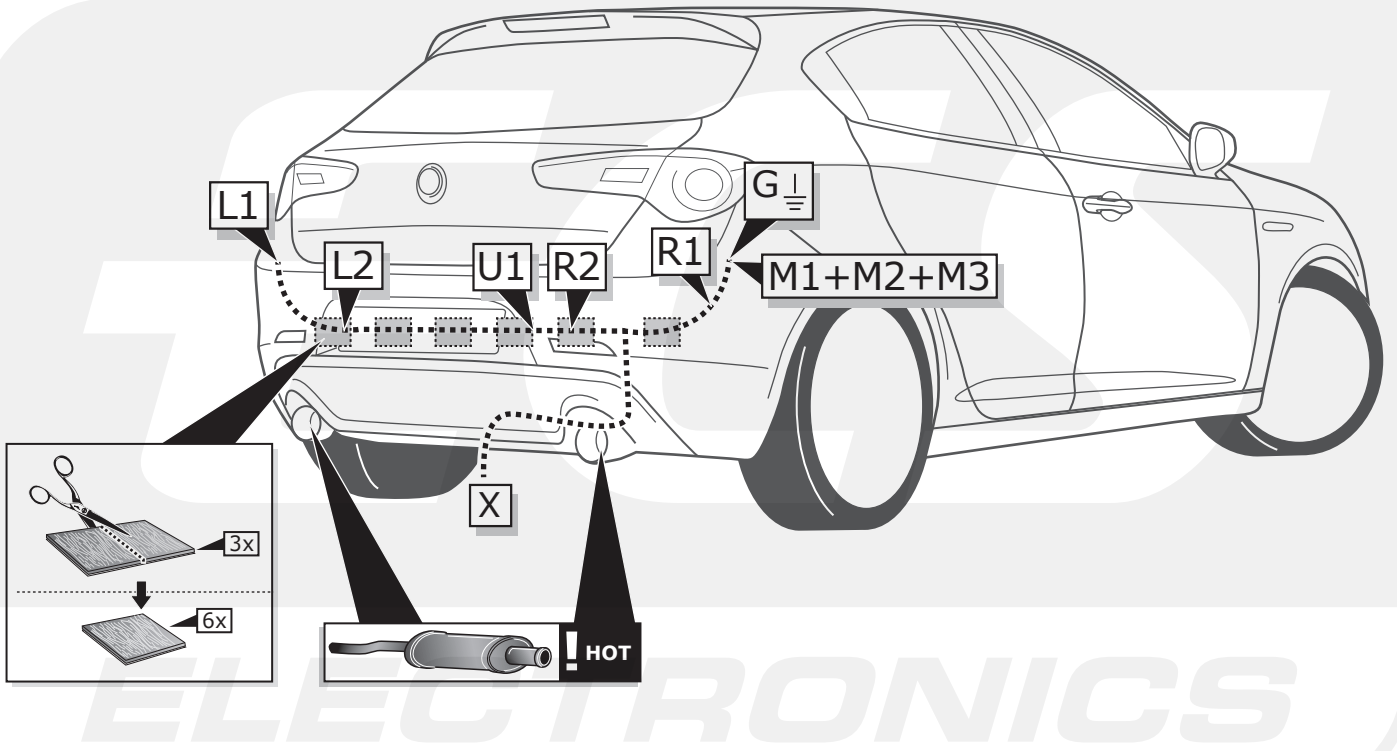

1

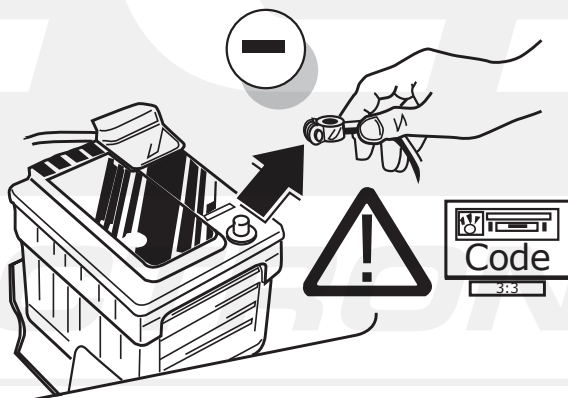

2

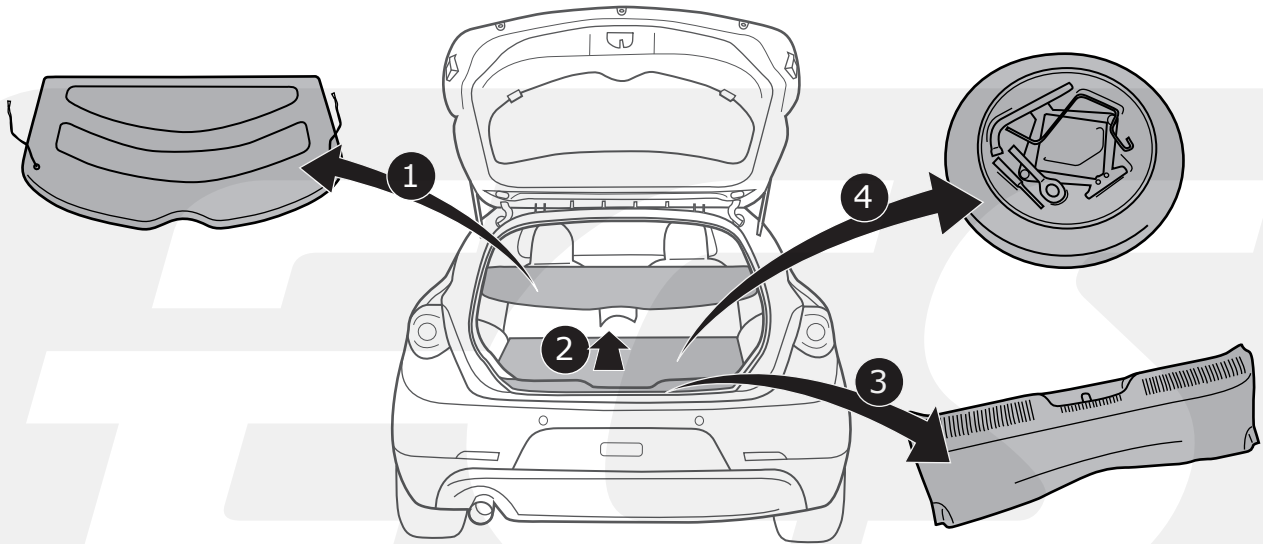

3

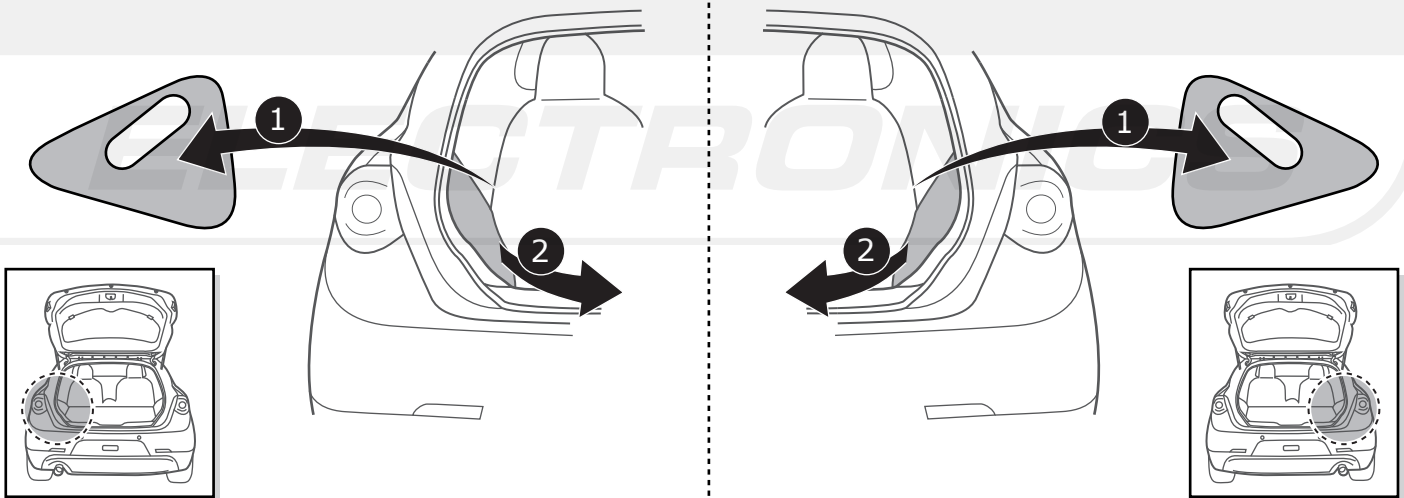

4

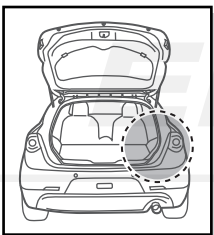
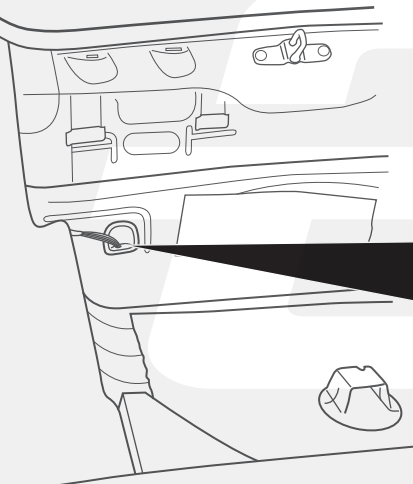

- | | |
|---------------------------------|--------------------------|
| DE Klebeband entfernen. | CZ Odstraňte pásku. |
| FR Enlevez Ruban adhésif. | DK Aftag tapen. |
| NL Tape verwijderen. | FI Poista teippi. |
| GB Remove tape. | GR Αφαιρέστε την ταινία. |
| ES Retirar la cinta adhesiva. | NO Fjern limbandet. |
| IT Rimuovere il nastro adesivo. | PL Zdjąć taśmę. |
| SE Avlägsna klisterbandet. | |

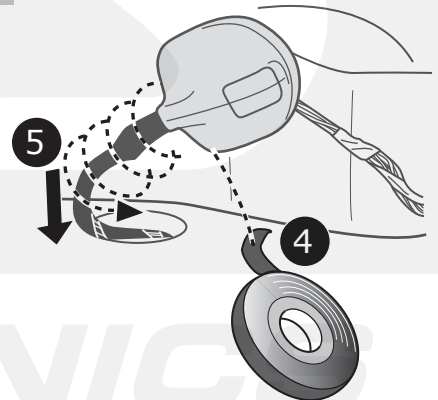
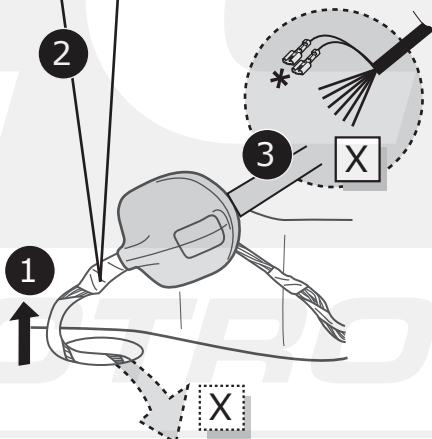

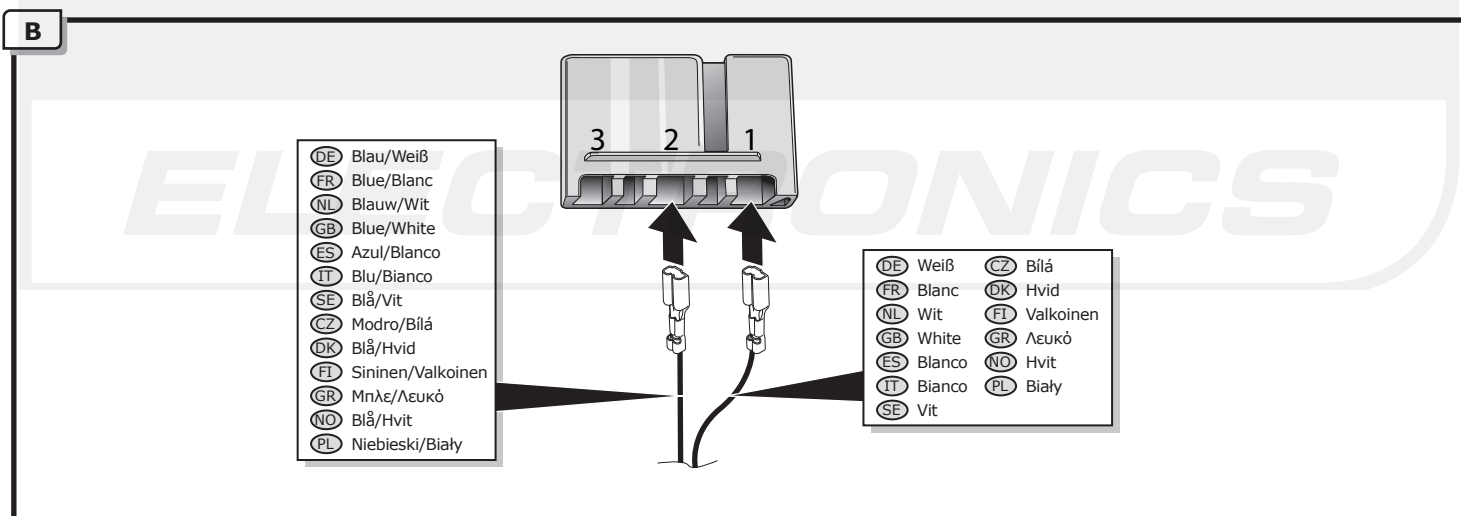
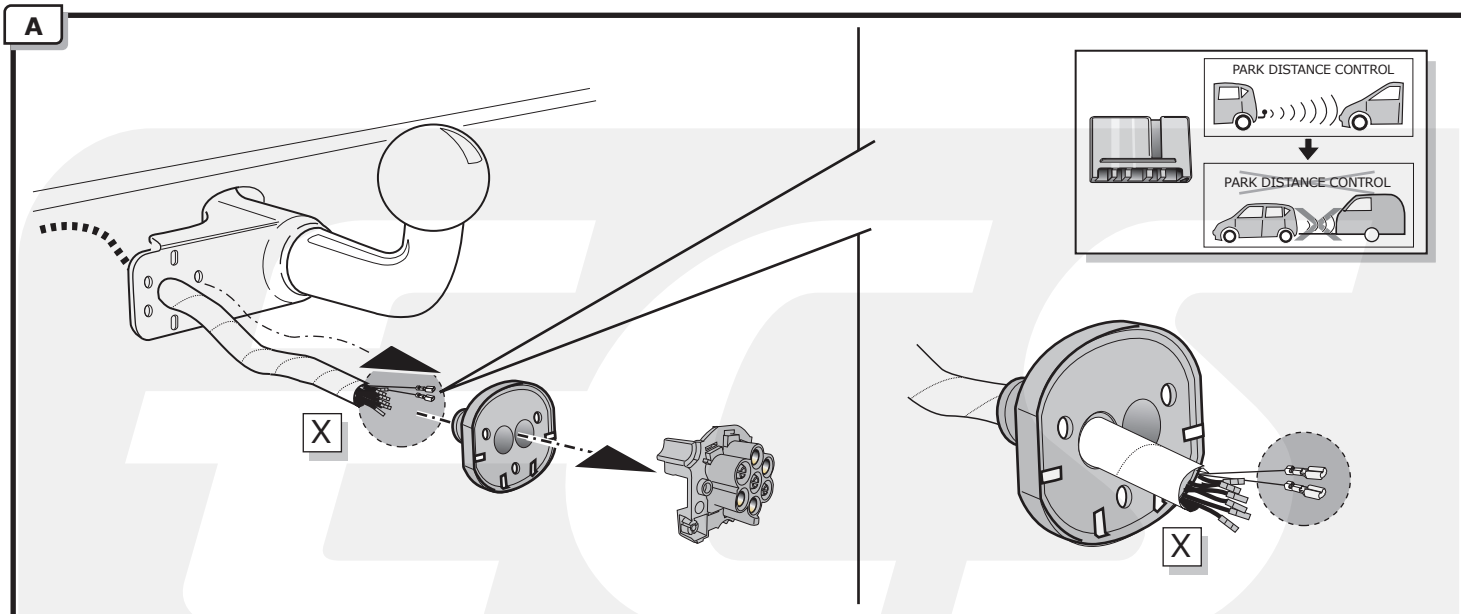

INFO

DE Anschluss Steckdose	SE Anslutning kontaktdosa
FR Connection de la prise	CZ Objímkový konektor
NL Contactdoos aansluiting	DK Stikdåse forbindelse
GB Socket connection	FI Pistorasia liitäntä
ES Conexión de la caja de enchufe	GR Υποδοχή σύνδεσης
IT Allaccio zoccolo	NO Tilkobling koblingsboks
	PL Połączenie przez gniazdo

Pag. 16

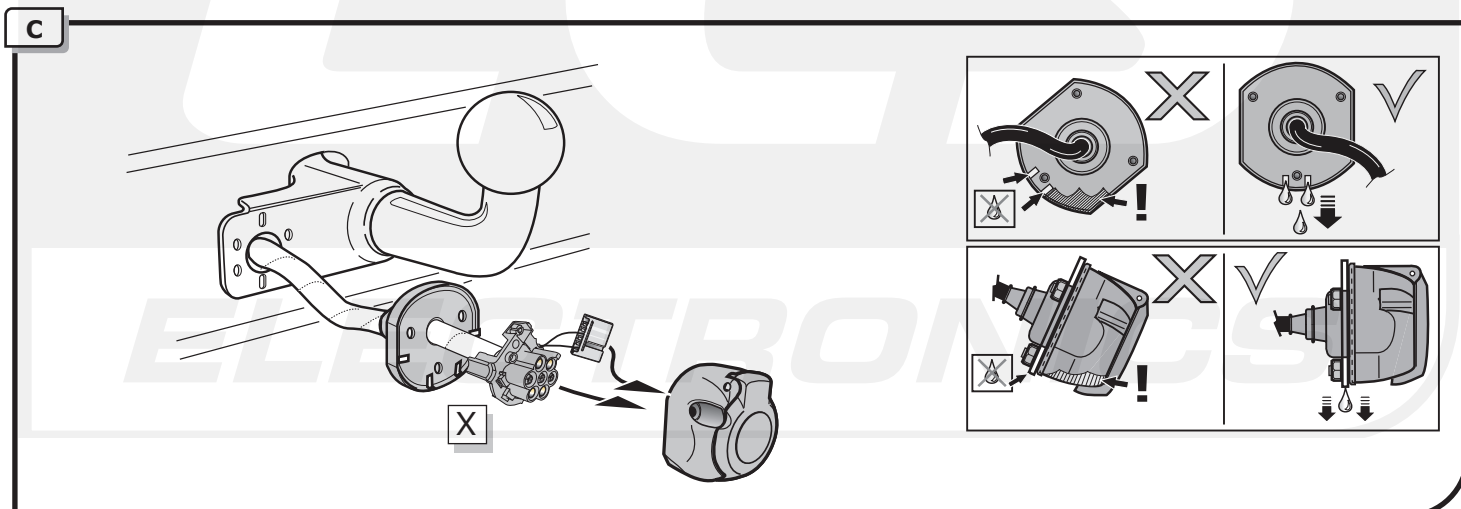

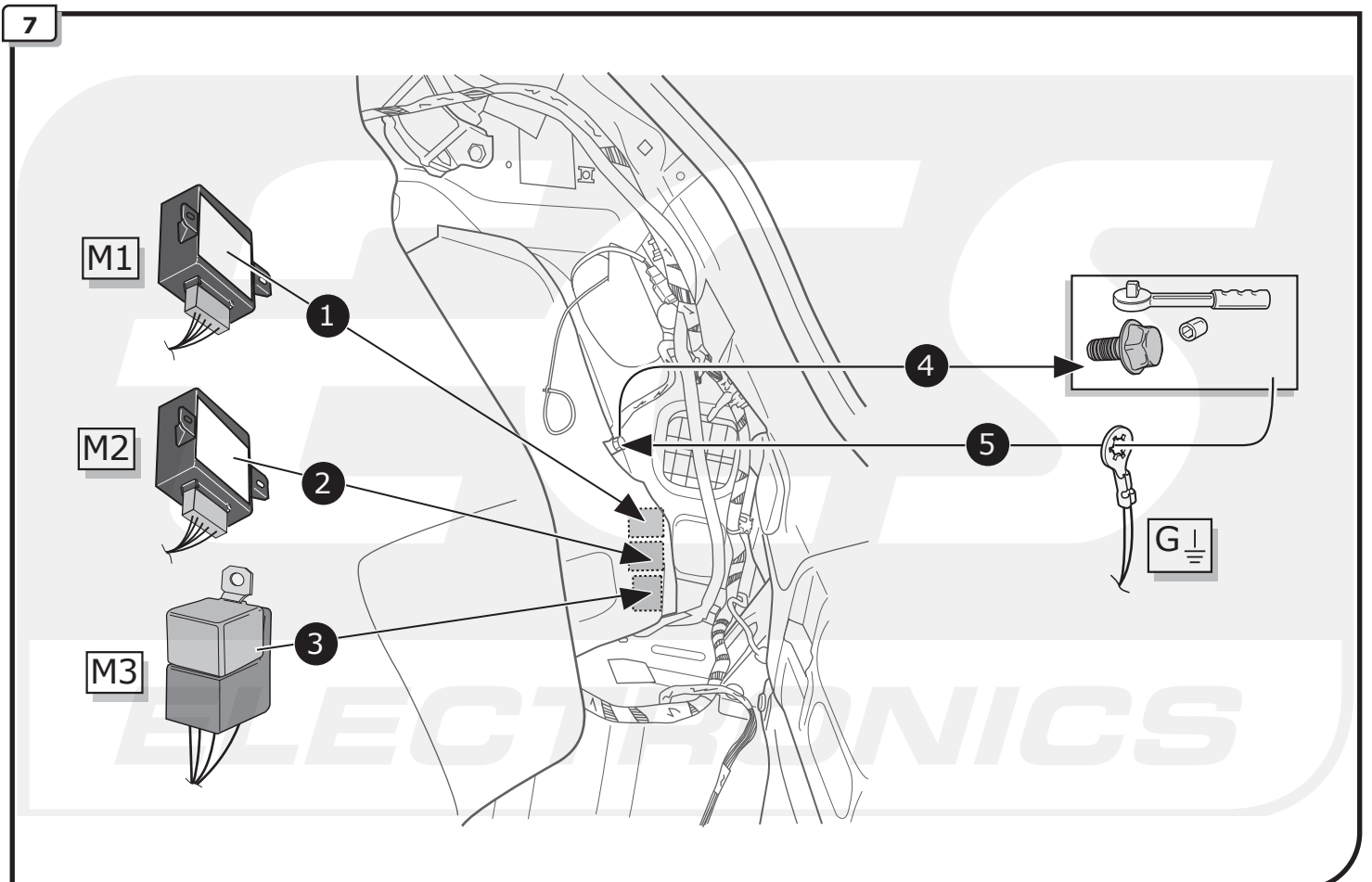
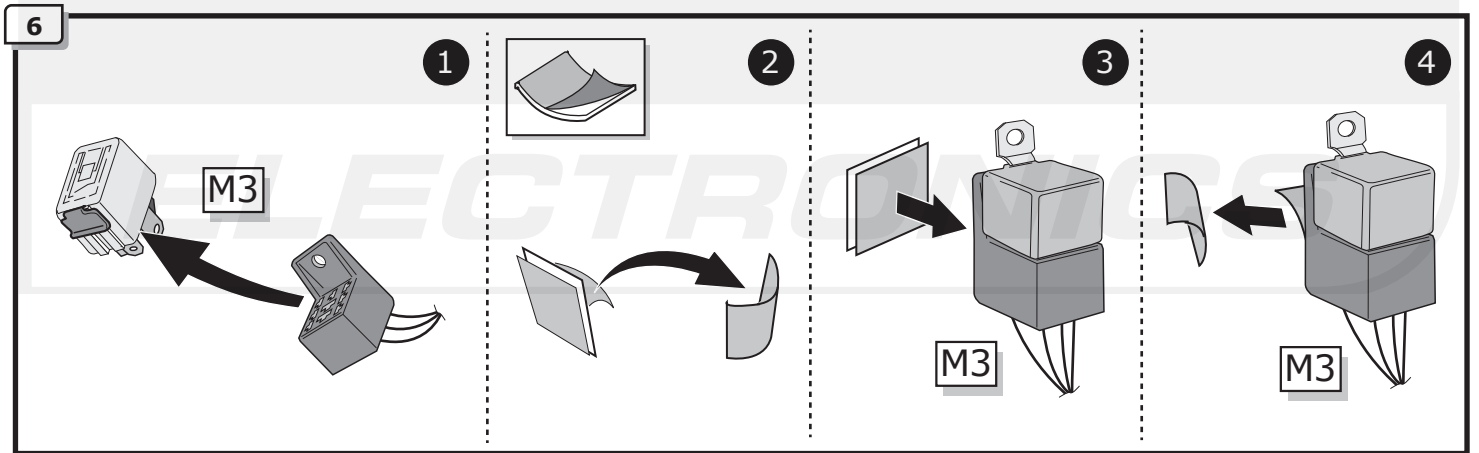
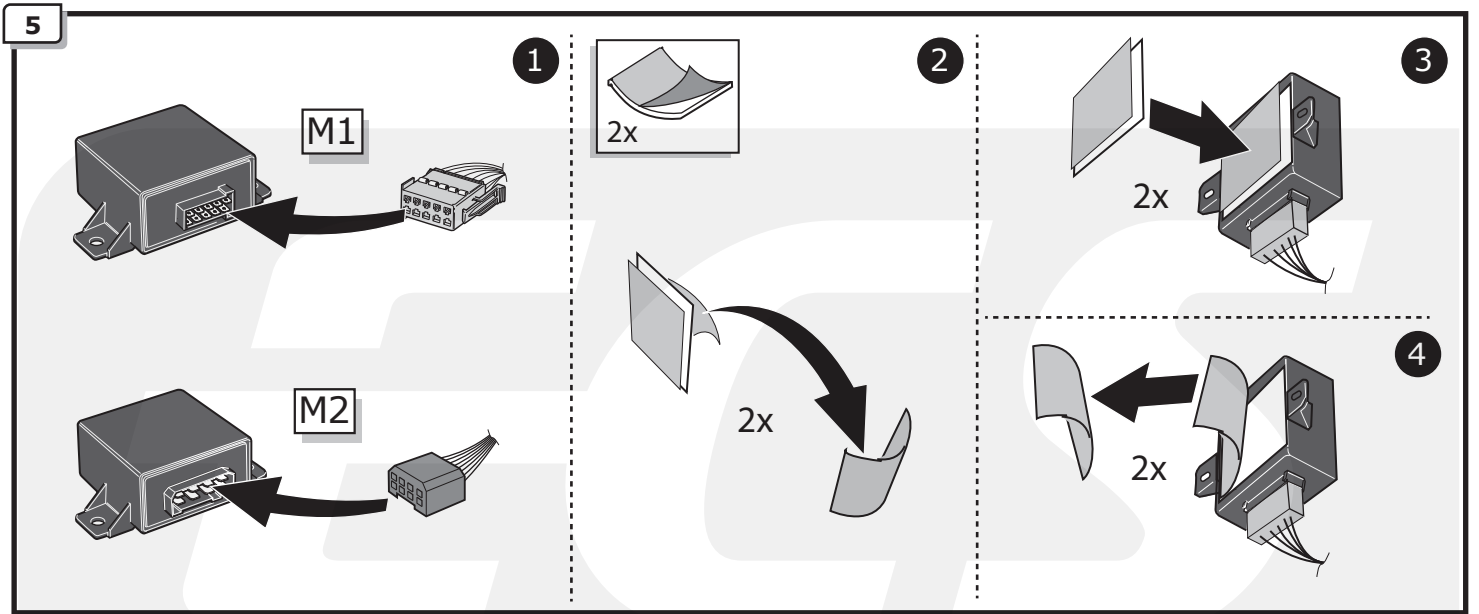

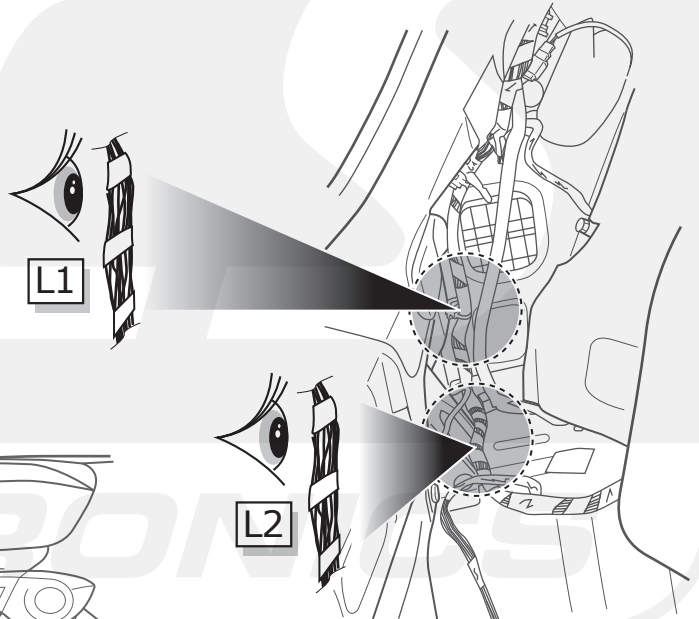
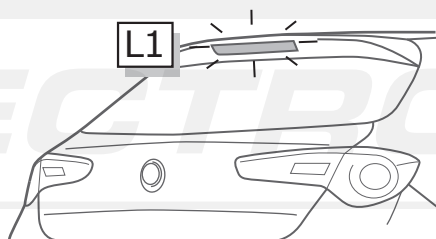
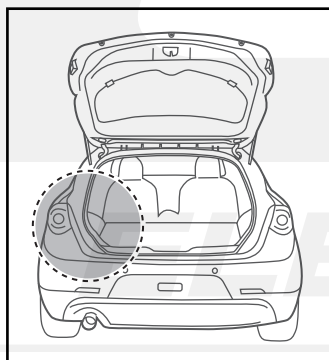
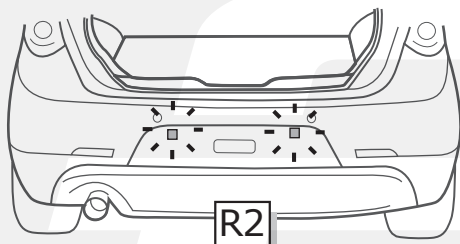
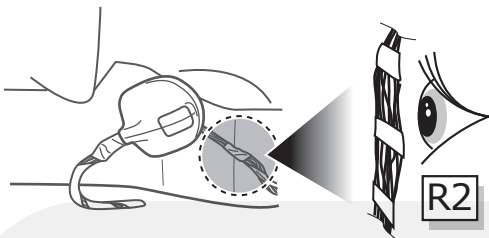
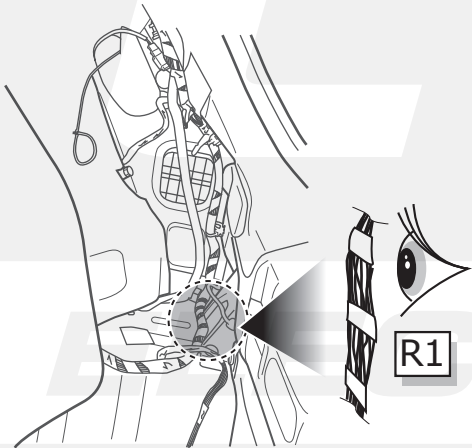
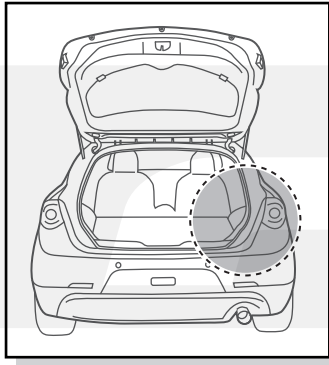

		(DE) Farben (FR) Couleurs (NL) Kleuren (GB) Colours (ES) Colores (IT) Colori (SE) Färgar	(CZ) Barevným (DK) Farverne (FI) Coloria (GR) χρώματα (NO) Farget (PL) Kolorować														
R1	R →																
R1	R ⦿																
R2	58L+58R ☀		<table border="1"> <tr> <td>(DE) Gelb/Grau</td> <td>(CZ) Žluto/Šedá</td> </tr> <tr> <td>(FR) Jaune/Gris</td> <td>(DK) Gul/Grå</td> </tr> <tr> <td>(NL) Geel/Grijs</td> <td>(FI) Keltainen/Harmaa</td> </tr> <tr> <td>(GB) Yellow/Grey</td> <td>(GR) Κίτρινο/Γκρι</td> </tr> <tr> <td>(ES) Amarillo/Gris</td> <td>(NO) Gul/Grå</td> </tr> <tr> <td>(IT) Giallo/Grigio</td> <td>(PL) Żółty/Szary</td> </tr> <tr> <td>(SE) Gul/Grå</td> <td></td> </tr> </table>	(DE) Gelb/Grau	(CZ) Žluto/Šedá	(FR) Jaune/Gris	(DK) Gul/Grå	(NL) Geel/Grijs	(FI) Keltainen/Harmaa	(GB) Yellow/Grey	(GR) Κίτρινο/Γκρι	(ES) Amarillo/Gris	(NO) Gul/Grå	(IT) Giallo/Grigio	(PL) Żółty/Szary	(SE) Gul/Grå	
(DE) Gelb/Grau	(CZ) Žluto/Šedá																
(FR) Jaune/Gris	(DK) Gul/Grå																
(NL) Geel/Grijs	(FI) Keltainen/Harmaa																
(GB) Yellow/Grey	(GR) Κίτρινο/Γκρι																
(ES) Amarillo/Gris	(NO) Gul/Grå																
(IT) Giallo/Grigio	(PL) Żółty/Szary																
(SE) Gul/Grå																	
L1	54 (STOP)		<table border="1"> <tr> <td>(DE) Grün/Schwarz</td> <td>(CZ) Zeleno/Černá</td> </tr> <tr> <td>(FR) Vert/Noir</td> <td>(DK) Grøn/Sort</td> </tr> <tr> <td>(NL) Groen/Zwart</td> <td>(FI) Vihreä/Musta</td> </tr> <tr> <td>(GB) Green/Black</td> <td>(GR) Πράσινο/Μαύο</td> </tr> <tr> <td>(ES) Verde/Negro</td> <td>(NO) Grønn/Svart</td> </tr> <tr> <td>(IT) Verde/Nero</td> <td>(PL) Zielony/Czarny</td> </tr> <tr> <td>(SE) Grön/Svart</td> <td></td> </tr> </table>	(DE) Grün/Schwarz	(CZ) Zeleno/Černá	(FR) Vert/Noir	(DK) Grøn/Sort	(NL) Groen/Zwart	(FI) Vihreä/Musta	(GB) Green/Black	(GR) Πράσινο/Μαύο	(ES) Verde/Negro	(NO) Grønn/Svart	(IT) Verde/Nero	(PL) Zielony/Czarny	(SE) Grön/Svart	
(DE) Grün/Schwarz	(CZ) Zeleno/Černá																
(FR) Vert/Noir	(DK) Grøn/Sort																
(NL) Groen/Zwart	(FI) Vihreä/Musta																
(GB) Green/Black	(GR) Πράσινο/Μαύο																
(ES) Verde/Negro	(NO) Grønn/Svart																
(IT) Verde/Nero	(PL) Zielony/Czarny																
(SE) Grön/Svart																	
L2	L ←																
L2	L ⦿																

	Farben Couleurs Kleuren Colours Colores Colori Färgar	Barevným Farverne Coloria χρώματα Färglet Kolorować
R1	R →	
R1	R ←	
R2	SBL+SBR	
L1	L →	
L1	L ←	

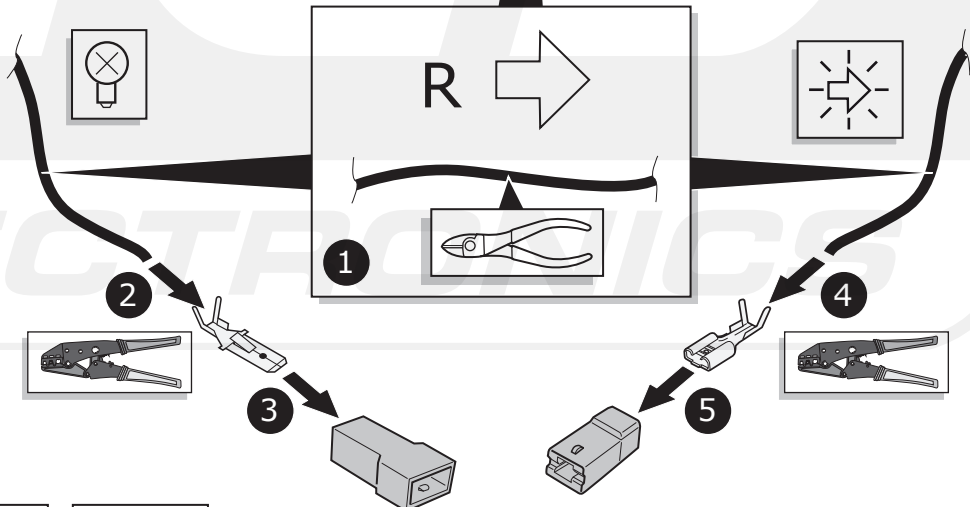
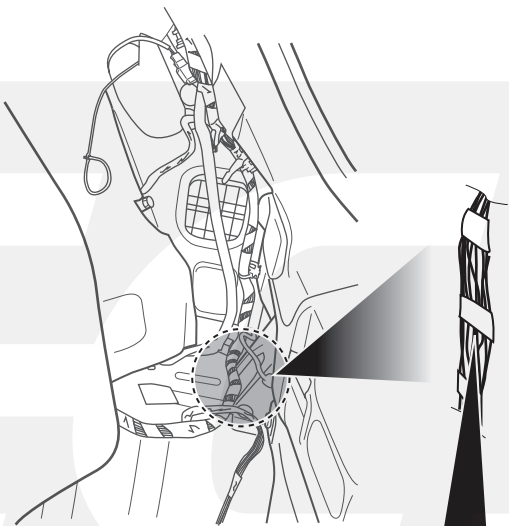
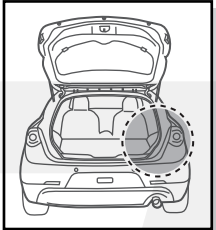

- 1x
- 1x
- 1x
- 1x

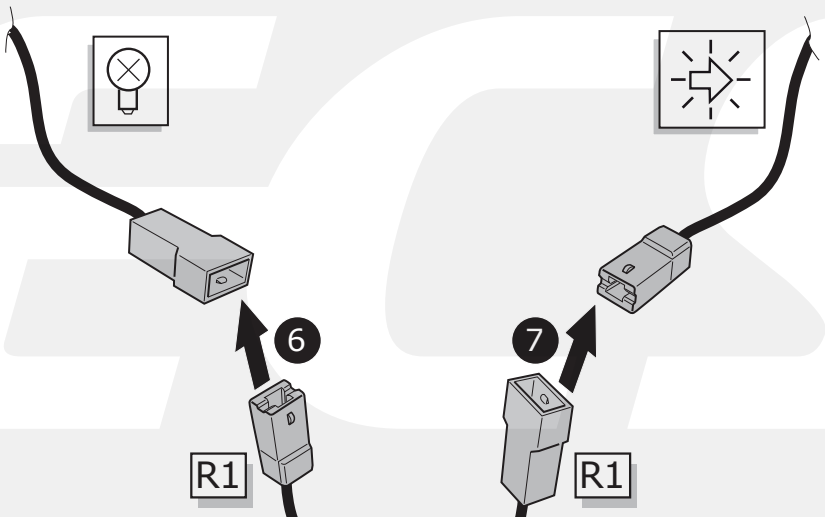

DE	Grün/Weiß	CZ	Zeleno/Bílá
FR	Vert/Blanc	DK	Grøn/Hvid
NL	Groen/Wit	FI	Vihreä/Valkoinen
GB	Green/White	GR	Πράσινο/Λευκό
ES	Verde/Blanco	NO	Grønn/Hvit
IT	Verde/Bianco	PL	Zielony/Biały
SE	Grön/Vit		

DE	Schwarz/Grün	CZ	Černo/Zelená
FR	Noir/Vert	DK	Sort/Grøn
NL	Zwart/Groen	FI	Musta/Vihreä
GB	Black/Green	GR	Μαύρο/Πράσινο
ES	Negro/Verde	NO	Svart/Grønn
IT	Nero/Verde	PL	Czarny/Zielony
SE	Svart/Grön		

11

	<ul style="list-style-type: none"> Farben Couleurs Cleuren Colours Colores Colori Färgar 	<ul style="list-style-type: none"> Barevným Fanverne Coloria χρώματα Farget Kolorować
R1	R →	
R1	R ←	
R2	SBL+SBR	
L1	S4	
L2	L →	
L2	L ←	

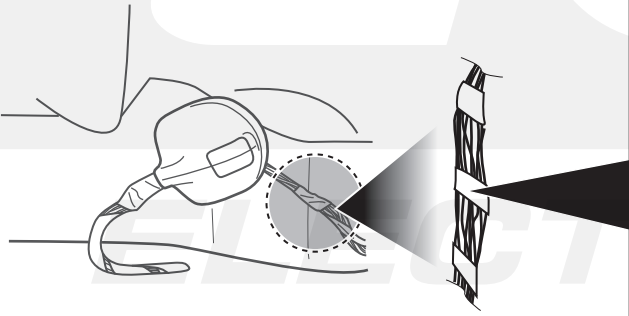
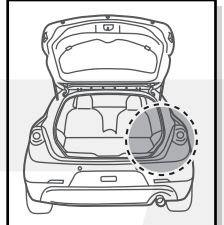
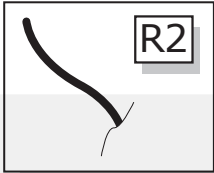
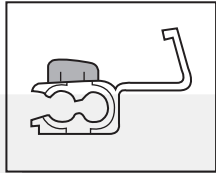

58L+58R

2

1

R2

58L+58R

DE Schwarz/Braun	CZ Černo/Hnědá
FR Noir/Marron	DK Sort/Brun
NL Zwart/Bruin	FI Musta/Ruskea
GB Black/Brown	GR Μαύρο/Καφέ
ES Negro/Marrón	NO Svart/Brun
IT Nero/Marrone	PL Czarny/Brazowy
SE Svart/Brun	

12

	<ul style="list-style-type: none"> Farben Couleurs Cleuren Colours Colores Colori Färgar 	<ul style="list-style-type: none"> Barevným Fanverne Coloria χρώματα Farget Kolorować
R1	R →	
R1	R ←	
R2	SBL+SBR	
L1	S4	
L2	L →	
L2	L ←	

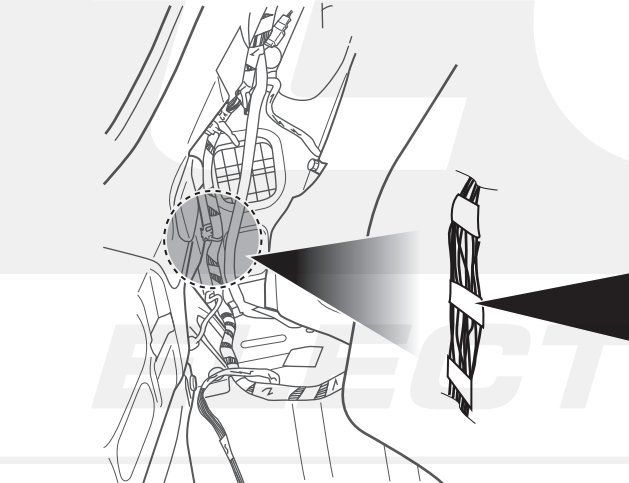
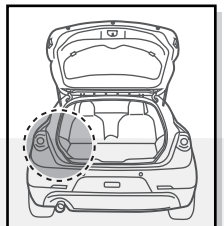
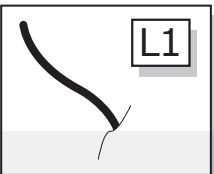
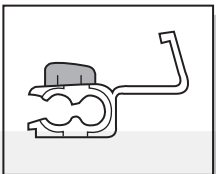

54 STOP

2

1

L1

54 STOP

DE Blau/Rot	CZ Modro/Červená
FR Blue/Rouge	DK Blå/Rød
NL Blauw/Rood	FI Sininen/Punainen
GB Blue/Red	GR Μπλε/Κόκκινο
ES Azul/Rojo	NO Blå/Rød
IT Blu/Rosso	PL Niebieski/Czerwony
SE Blå/Röd	

	● Farben ● Couleurs ● Kleuren ● Colours ● Cores ● Colori ● Färgar	● Barevným ● Fanverne ● Coloria ● χρώματα ● Färget ● Kolorować
R1	R →	
R1	R ←	
R2	SBL+SBR	
L1	L →	
L1	L ←	

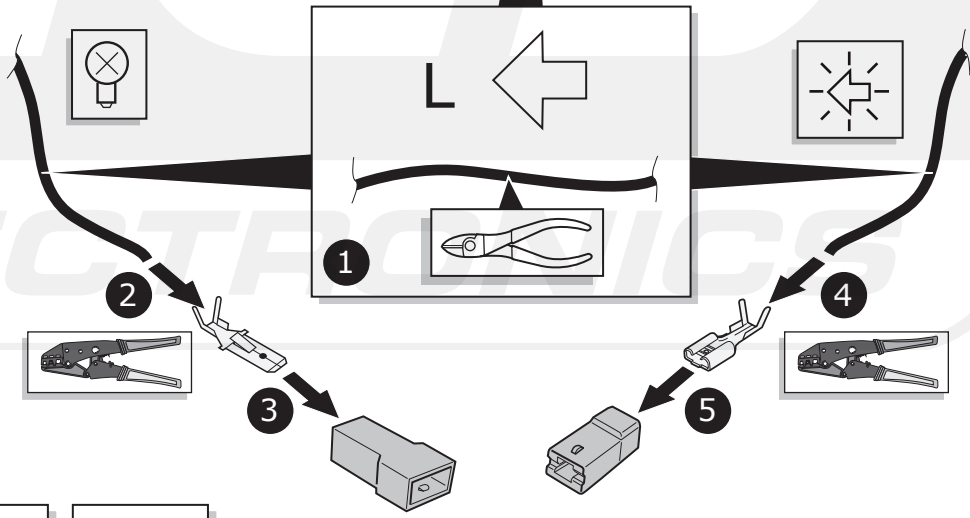
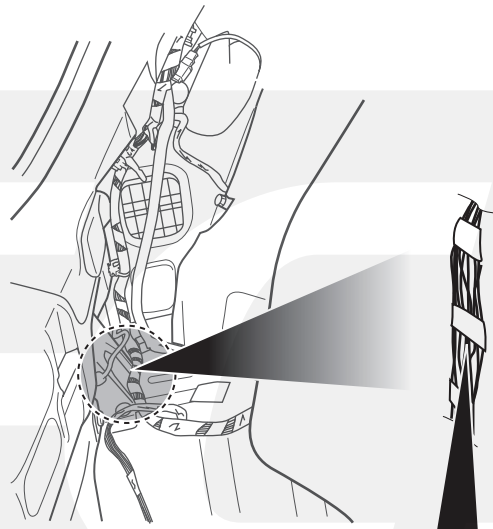
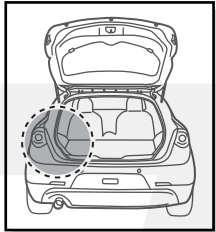

- 1x
- 1x
- 1x
- 1x

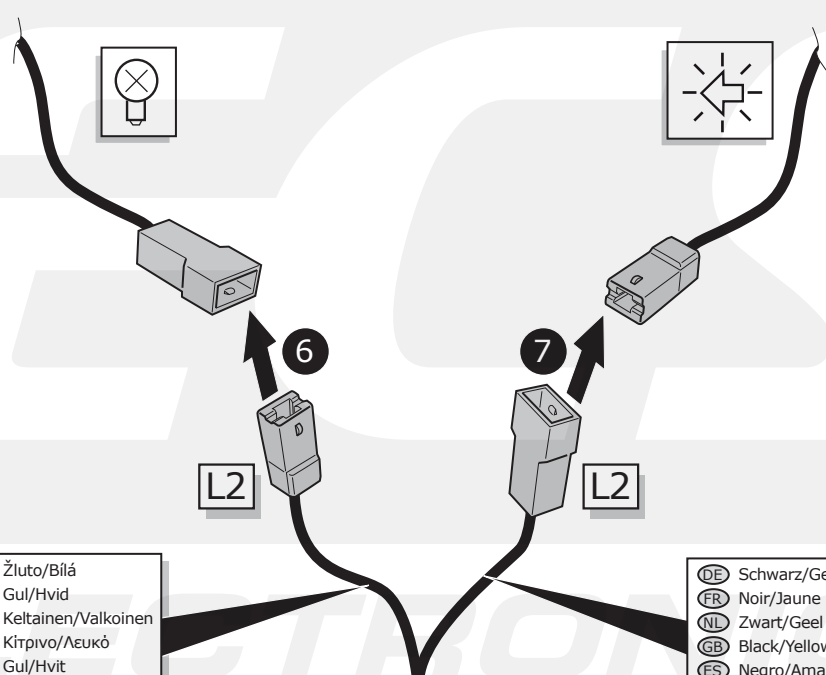

DE Gelb/Weiß	CZ Žluto/Bílá
FR Jaune/Blanc	DK Gul/Hvid
NL Geel/Wit	FI Keltainen/Valkoinen
GB Yellow/White	GR Κίτρινο/Λευκό
ES Amarillo/Blanco	NO Gul/Hvit
IT Giallo/Bianco	PL Żółty/Biały
SE Gul/Vit	

DE Schwarz/Gelb	CZ Černo/Žlutá
FR Noir/Jaune	DK Sort/Gul
NL Zwart/Geel	FI Musta/Keltainen
GB Black/Yellow	GR Μαύρο/Κίτρινο
ES Negro/Amarillo	NO Svart/Gul
IT Nero/Giallo	PL Czarny/Żółty
SE Svart/Gul	

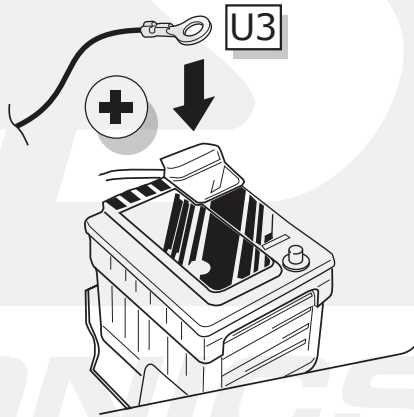
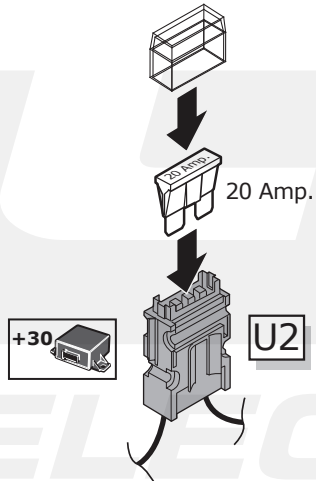
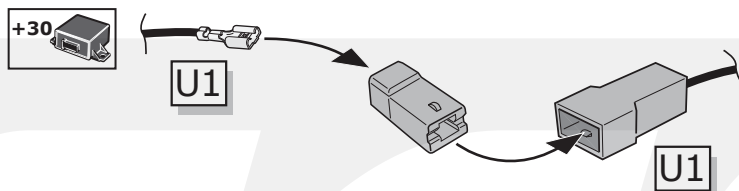

OPTION

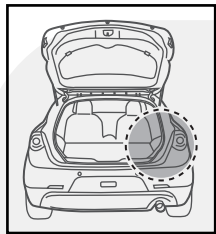

- | | | | |
|----|---------|----|---------|
| DE | Braun | CZ | Hnědá |
| FR | Marron | DK | Brun |
| NL | Bruin | FI | Ruskea |
| GB | Brown | GR | Καφέ |
| ES | Marrón | NO | Brun |
| IT | Marrone | PL | Brązowy |
| SE | Brun | | |

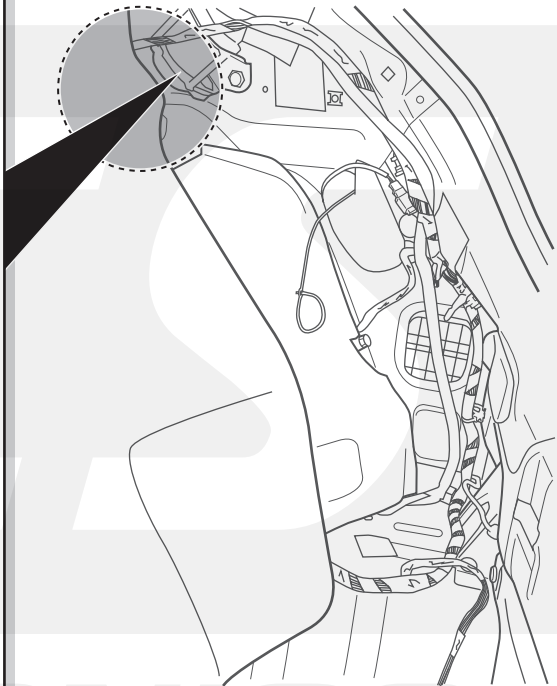
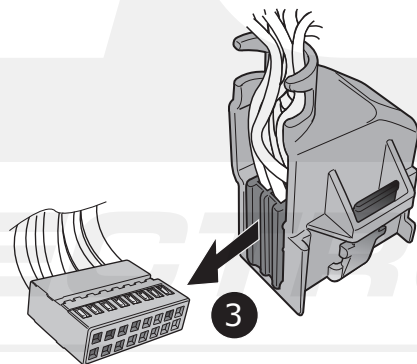
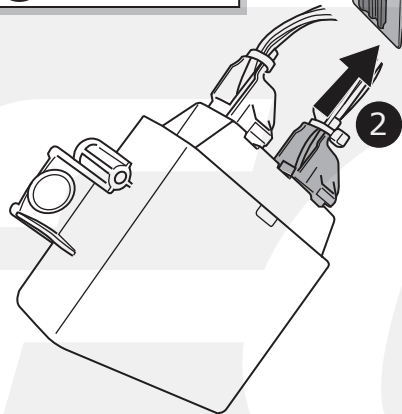
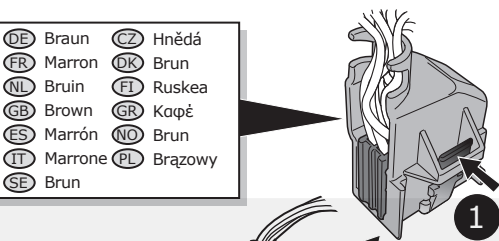

OPTION

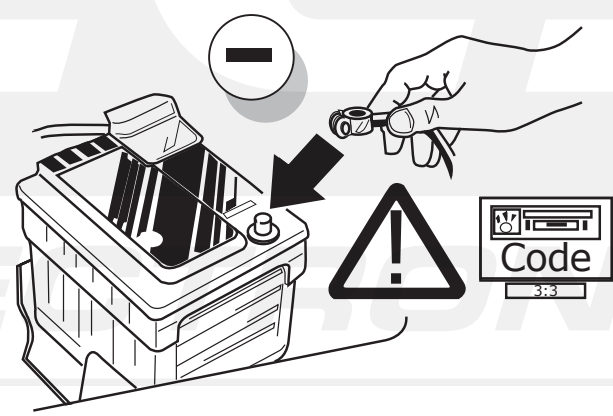
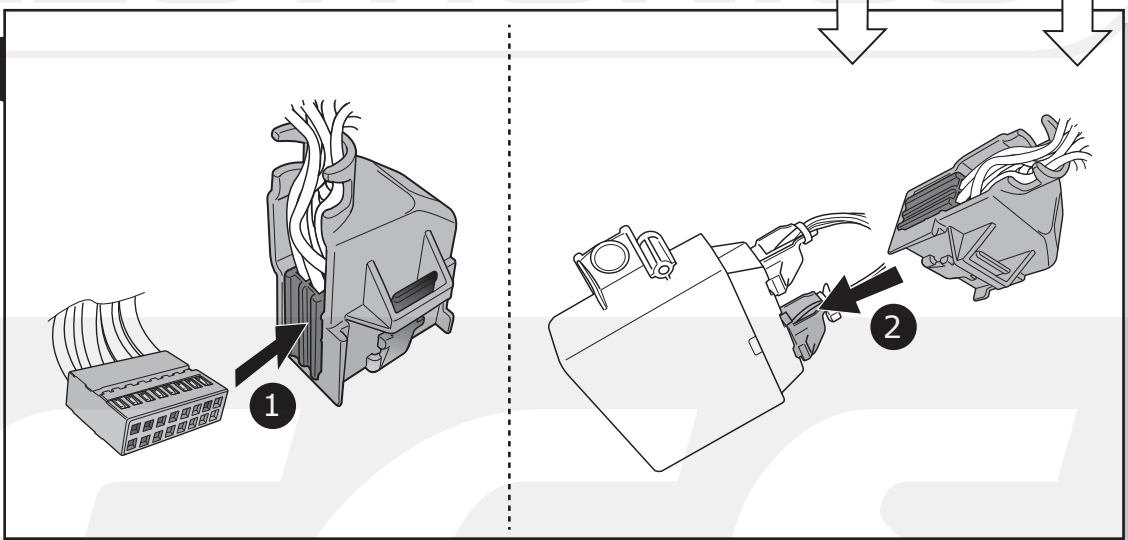
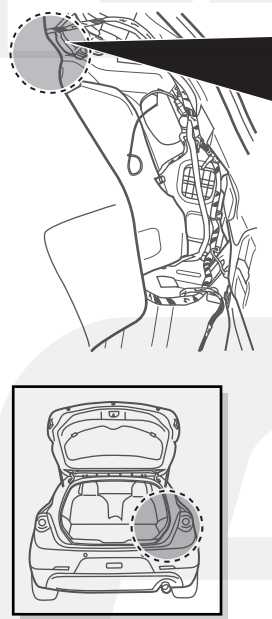
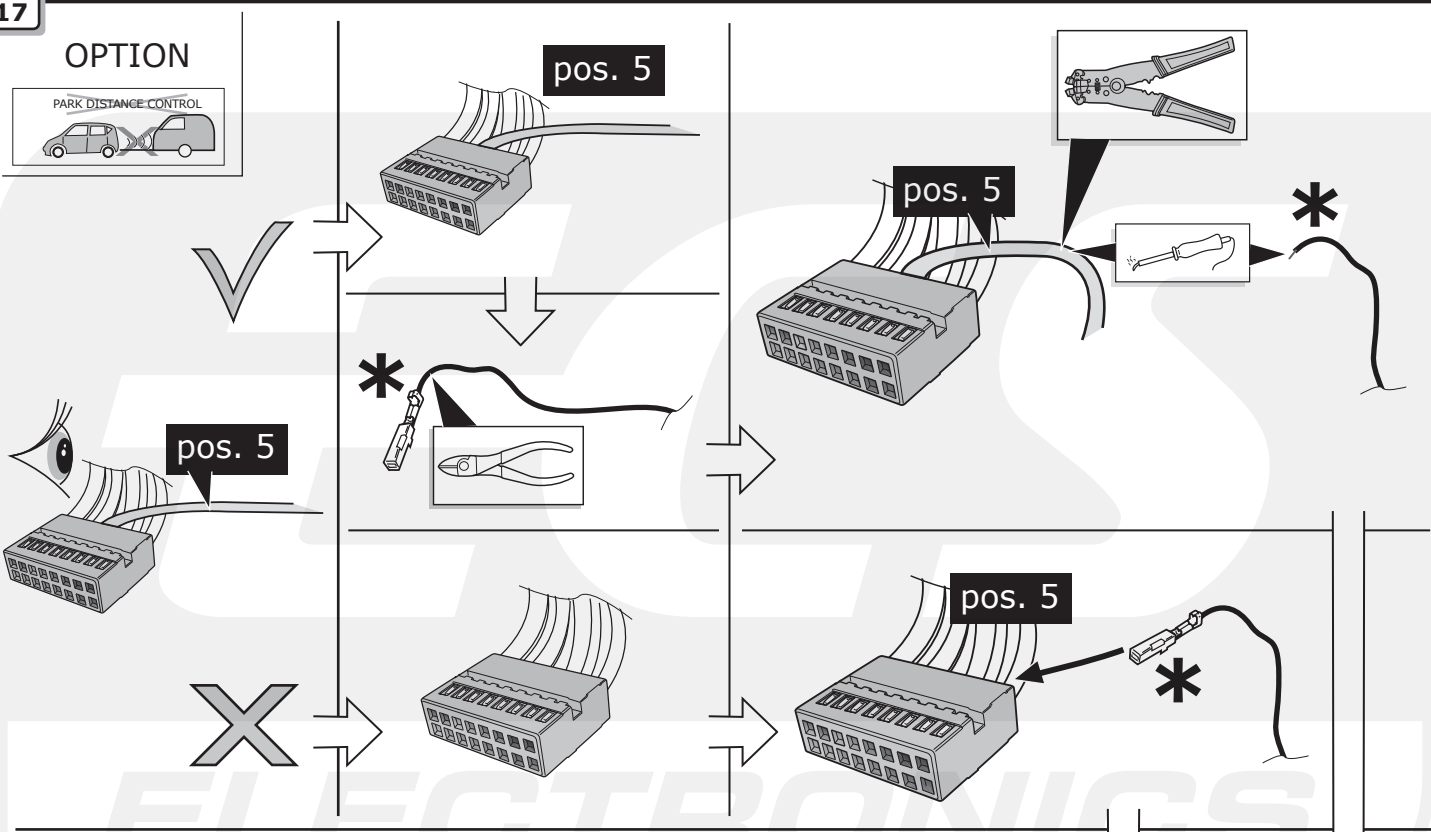
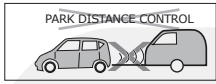

19

- (DE) FUNKTIONEN KONTROLLIEREN MIT EINEM PRÜFGERÄT MIT WIDERSTAND ODER MIT LEUCHTEN MIT DER GENAUEN WATTZAHL!
- (FR) CONTRÔLER LES FONCTIONS AVEC UNE BOÎTE DE TEST AVEC DE LA CHARGE OU DES LAMPES AVEC LA QUANTITÉ CORRECTE DE WATT!
- (NL) CONTROLEER FUNCTIES MET EEN TESTER MET BELASTING OF LAMPEN MET DE JUISTE WATTAGE!
- (GB) TEST ALL CIRCUIT FUNCTIONS WITH A TESTBOX WITH THE CORRECT POWER LOAD FOR EACH UNIT. A TESTBOX ON WHICH ONLY LEDs ARE USED CAN NOT BE USED IN THIS CASE
- (ES) ¡CONTROLAR FUNCIONES CON UN TESTER CON CARGA O LUCES CON EL CORRECTO WATTAJE!
- (IT) CONTROLLA FUNZIONI CON UN TESTER CON CARICO O LAMPADIE DEL GIUSTO WATT-TAGGIO!
- (SE) KONTROLLERA FUNKTIONERNA MED EN TESTARE MED BELASTNING ELLER LAMPOR MED RÄTT WATT-VÄRDE!
- (CZ) OVĚŘTE FUNKCE POMOČÍ TESTOVACÍHO BOXU NEBO SVĚTEL S PŘÍSLUŠNÝM VÝKONEM!
- (DK) CHECK FUNKTIONERNE MED EN TESTBOKS, MED BELASTNING ELLER MED LYGTER MED DET KORREKTE ANTAL WATT!
- (FI) TARKISTA TOIMINNOT KÄYTTÄMÄLLÄ TESTILAITE, JOSSA ON OIKEATEHOINEN KUORMITUS TAI OIKEATEHOISET LAMPUT!
- (GR) ΕΛΕΓΕΤΕ ΤΙΣ ΛΕΙΤΟΥΡΓΙΕΣ ΜΕ 'ΕΝΑ ΚΙΒΩΤΙΟ ΔΟΚΙΜΗΣ ΜΕ ΦΟΡΤΙΟ Ή ΛΑΜΠΙΤΗΡΕΣ ΣΩΣΤΗΣ ΠΟΣΟΤΗΤΑΣ ΒΑΤ!
- (NO) KONTROLER FUNKSJONENE MED EN TESTER MED BELASTNING ELLER LYSPÆRER MED RIKTIG WATTVERDI!
- (PL) SPRAWDŹ FUNKCJE UŻYWAJĄC SKRZYŃKI TESTOWEJ Z OBCIĄŻENIEM LUB PODŁĄCZONYMI ŻARÓWKAMI O ODPOWIEDNIEJ MOCY!

20

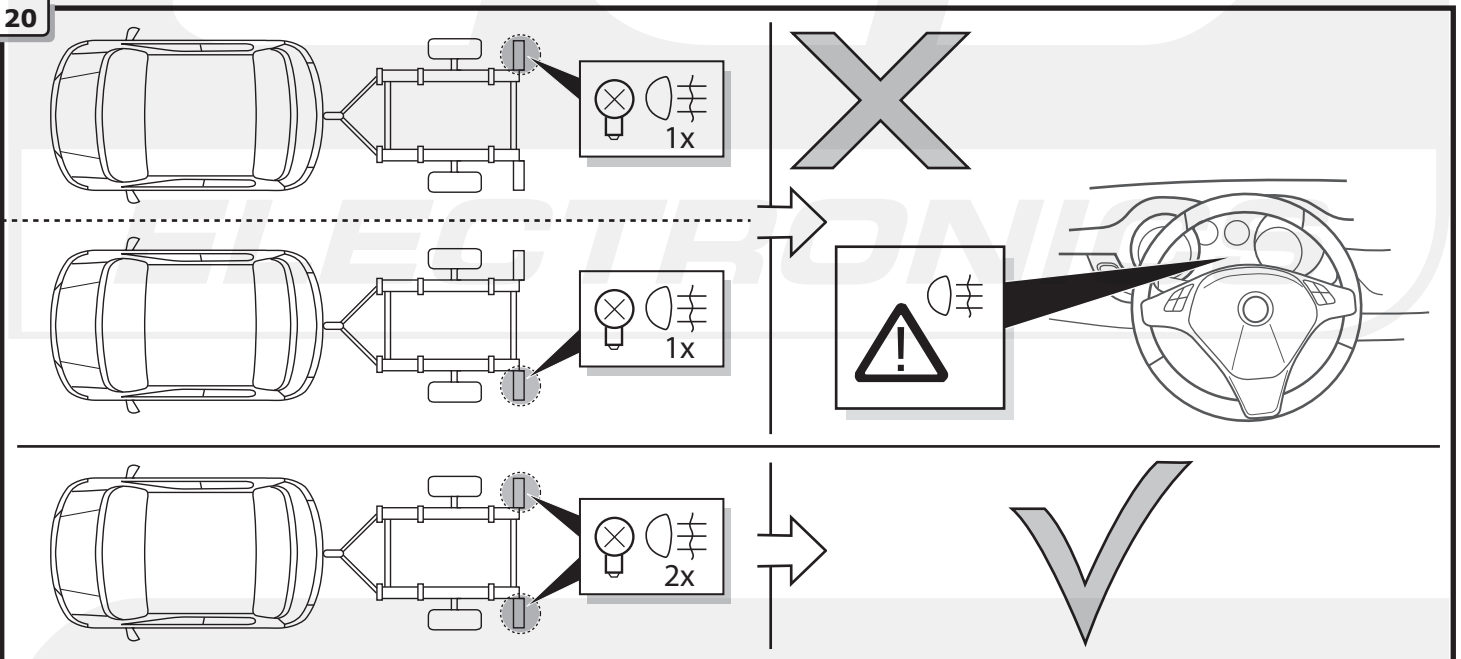

INFO

- (DE) Einzelteile wieder einbauen
- (FR) Montez les part enlevées
- (NL) Terug plaatsen onderdelen
- (GB) Reinstall linings
- (ES) Reinstalar componentes
- (IT) Rimetti a posto componenti
- (SE) Sätt tillbaka delar
- (CZ) Znovu zasuňte obložení
- (DK) Påsæt beklædningen
- (FI) Asenna verhoilut takaisin
- (GR) Τοποθετήστε ξανά τις επενδύσεις
- (NO) Sett tilbake deler
- (PL) Założyć wykładzinę

21



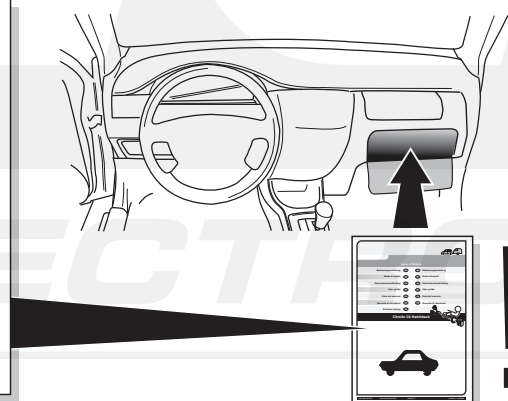



- (DE) Gebrauchsanleitung.
- (FR) Mode d'emploi.
- (NL) Gebruikershandleiding.
- (GB) User guide.
- (ES) Guía del usuario.
- (IT) Manuale di istruzioni.
- (SE) Bruksanvisning.
- (CZ) Uživatelská příručka.
- (DK) Brugervejledning.
- (FI) Käyttöohjeet.
- (GR) Οδηγός χρήστη.
- (NO) Brukerveiledning.
- (PL) Instrukcja obsługi.

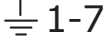

00800
CALL2ECS
22 55 23 27

09.00 - 18.00
Monday - Friday
www.ecs-electronics.nl

- (DE) Anschluss Steckdose
- (FR) Connection de la prise
- (NL) Contactdoos aansluiting
- (GB) Socket connection
- (ES) Conexión de la caja de enchufe
- (IT) Allaccio zoccolo
- (SE) Anslutning kontaktdosa
- (CZ) Objímkový konektor
- (DK) Stikdåse forbindelse
- (FI) Pistorasia liitäntä
- (GR) Υποδοχή σύνδεσης
- (NO) Tilkobling koblingsboks
- (PL) Połączenie przez gniazdo

DIN/ISO 1724							
	1/L	2	3/31	4/R	5/58-R	6/54	7/58-L
Pmax	21W	2x21W		21W	52W	3x21W	52W
(DE)	Gelb	Blau	Weiß	Grün	Braun	Rot	Schwarz
(FR)	Jaune	Bleu	Blanc	Vert	Marron	Rouge	Noir
(NL)	Geel	Blauw	Wit	Groen	Bruin	Rood	Zwart
(GB)	Yellow	Blue	White	Green	Brown	Red	Black
(ES)	Amarillo	Azul	Blanco	Verde	Marrón	Rojo	Negro
(IT)	Giallo	Blu	Bianco	Verde	Marrone	Rosso	Nero
(SE)	Gul	Blå	Vit	Grön	Brun	Röd	Svart
(CZ)	Žlutá	Modrá	Bílá	Zelená	Hnědá	Červená	Černá
(DK)	Gul	Blå	Hvid	Grøn	Brun	Rød	Sort
(FI)	Keltainen	Sininen	Valkoinen	Vihreä	Ruskea	Punainen	Musta
(GR)	Κίτρινο	Μπλε	Λευκό	Πράσινο	Καφέ	Κόκκινο	Μαύρο
(NO)	Gul	Blå	Hvit	Grønn	Brun	Rød	Svart
(PL)	Żółty	Niebieski	Biały	Zielony	Brązowy	Czerwony	Czarny